



Sahyadri Shikshan Mandal's

**Mahant Jamanadas Maharaj**

**Arts, Commerce and Science College**

Karanjali, Tal. Peth, Dist. Nashik – 422208, (MS) India

**(Affiliated to Savitribai Phule Pune University, Pune)**

**Accredited by NAAC- 'C' Grade (CGPA-1.72)**



## **Criterion-III:**

### **Research, Innovations and Extension**

#### **3.2.: Innovation Ecosystem**

**3.2.1:** Institution has created an ecosystem for innovations, Indian knowledge System (IKS), including awareness about IPR establishment of IPR cell, Incubation centre and other initiatives for the creation and transfer of knowledge/technology and the outcomes of the same are evident during 2018-2019 to 2022-2023.

॥ स्वदेशे पुज्यते राजा विन्दान्सर्वत्र पुज्यते ॥  
Govt. of Mah. Order No. N.G.C. 2009 (152/09) MS R - 4  
Sahyadri Shikshan Mandal's Dindori  
**Mahant Jamanadas Maharaj**  
**ARTS, COMMERCE & SCIENCE COLLEGE**  
Karanjali, Tal. Peth, Dist. Nashik. (Maharashtra) 422 208. Ph.No.: 02558 - 234666  
E-mail : mjmccollege1@yahoo.com College Code - 908

ID No. PU/NS/ACS/150/2009

जावक क्र.: 186/2024-25 दिनांक : 20/12/2024

**DECLARATION**

This is to declare that the information, reports, true copies of the supporting documents, numerical data etc. submitted / Presented in the files is verified by Internal Quality Assurance Cell (IQAC) and it is correct as per the record.

This declaration is for the purpose of NAAC accreditation of HEI for the 2<sup>nd</sup> cycle period 2018-2019 to 2022-23.

Date:-20/12/2024  
Place:-Karanjali

*Dr. M.S. Shinde*  
**Dr. M.S. Shinde**  
**I.Q.A.C. Co-ordinator**  
**M.J.M. Arts, Commerce and Science College**  
Karanjali, Nashik-422 208

*Dr. U.P. Shinde*  
**Dr. U.P. Shinde**  
**Principal**  
**M.J.M. Arts, Commerce & Science College Karanjali,**  
Tal.Peth, Dist.Nashik

Sahyadri Shikshan Mandal,  
Karanjali, Tal.: Peth, Dist.: Nashik.  
Pin : 422 208, Ph.: 02558 234666 / +91 9420002030

3.2.1: Institution has created an ecosystem for innovations, Indian knowledge System (IKS), including awareness about IPR establishment of IPR cell, Incubation centre and other initiatives for the creation and transfer of knowledge/technology and the outcomes of the same are evident during 2018-2019 to 2022-2023.

## Table of Contents

❖ General Introductions	-----	4
❖ List of Patents	-----	6
	-	
❖ List of Research Guide	-----	8
	-	
❖ List of Research Students	-----	8
	-	
❖ Documents of Patents	-----	11
	-	
❖ Documents of Research Guide	-----	83
	-	
❖ Documents of Research Students	-----	91
	-	

3.2.1: Institution has created an ecosystem for innovations, Indian knowledge System (IKS), including awareness about IPR establishment of IPR cell, Incubation centre and other initiatives for the creation and transfer of knowledge/technology and the outcomes of the same are evident during 2018-2019 to 2022-2023.

#### **General Introduction of Innovations and incubation**

The institution Mahant Jamanadas Maharaj College of Arts, Commerce and Science, Karanjali, has created an ecosystem for innovation and initiation of several activities. The main interest of Incubation and innovation cell is to cultivate the basics of innovations among the faculties and students. The Incubation and innovation cell has a main role of creation and transfer of knowledge regarding the innovative things. Our institution is committed for fulfillment of the needs of the as per the research point of view. The institution is also working as a bridge between society and stakeholders for transferring the knowledge, innovations and some scientific solutions for the problem encountered.

Our institution ecosystem developing the novel ideas for research-based skills and knowledge-based things. Our institution has well established Academic research Committee (ARC) which can maintain the research collaboration and research culture among the faculty members. ARC promotes the faculty members and students to develop the research culture by providing necessary collaboration and research-based activities in the college. We have collaboration with various educational institutes and we have jointly shared with various research idea and facilities. Due to these facilities, we have significant number of publications in peer-reviewed journals of repute and patents. Research and innovative ideas of the scholars are cultivated through an ecosystem. Our faculty members regularly participated in the conferences,

### Criterion III: Research, Innovations and Extension –

seminars and workshops. This ultimately benefits to develop the competencies among students and encouraging for Avishkar competitions. HEI has well-defined research promotion policy that helps to guide the researchers on ethics, short term projects, and completion of Ph.Ds, publish research findings in quality journals and file patents resulting from research addressing regional problems.

The incubation center conducts IPR lecture periodically for the development of the staff members in the field of innovations. The innovative competitions like AVISHKAR and Chemiad quiz competitions boost our students for innovative projects and knowledge through their creative thinking and research interest. Our institution has 04 PhD guides and 09 Ph.Ds are registered under Ph.D. guides at affiliated research center. During last five years 2 faculty members are awarded by Ph.D. from recognized universities and currently 5 faculty members are perusing Ph.D. from various recognized university. Outcome of research facility is 95 journal publications, 19 book chapters/proceedings and 21 patents. For an innovative ecosystem college established collaborations, signed 33 MoUs with national and international academic, research and industrial organizations to facilitate multi-and interdisciplinary research, training and developments. Our students visited several industries under collaborative activities. During the COVID 19 epidemic, the collaborative learning platforms and virtual classroom are extremely helpful. The climate for innovative research has been made more favourable by career oriented, add-on, and value-added courses.

3.2.1. Institution has created an ecosystem for innovations and has initiatives for creation and transfer of knowledge (patents filed, published, incubation center facilities in the HEI to be considered)

❖ **Patents Filed/ Published:**

Sr.No	Name of faculty	Department	Title of Patent	Date of Filing	Date of Publication	Status of Patent (Filed/ Published)
1.	Dr.P.T.Wankhedkar	Zoology	Nanoparticle Based Cancer Medication Device	13/05/2023	11/08/2023	Published
2.	Dr.P.T.Wankhedkar	Zoology	Device to Identify Type of Poison in Blood	30/01/2023	12/05/2023	Published
3.	Dr.P.T.Wankhedkar	Zoology	Insulin Injector Device	16/11/2022	03/03/2023	Published
4.	Dr.P.T.Wankhedkar	Zoology	Heart Attack Preventing Device	15/11/2022	21/02/2023	Published
5.	Dr.P.T.Wankhedkar	Zoology	Device to Identify Animal Stress	03/12/2022	03/02/2023	Published
6.	Dr.P.T.Wankhedkar	Zoology	Device to Detect Drug Resistance	16/12/2022	03/02/2023	Published
7.	Dr.P.T.Wankhedkar	Zoology	Device to Detect Hemostatic Function in Animals	16/12/2022	27/01/2023	Published

Criterion III: Research, Innovations and Extension –

8.	Dr.P.T.Wankhedkar	Zoology	System to Assess and Identify the Casualty of the Wound Tissue Using Artificial Intelligence	04/12/2022	30/12/2022	Published
9.	Dr.P.T.Wankhedkar	Zoology	Insulin Injecting Device	02/09/2022	25/10/2022	Published
10.	Dr.P.T.Wankhedkar	Zoology	Bird Nest Monitoring Device	04/08/2022	23/12/2022	Published
12.	Dr.P.T.Wankhedkar	Zoology	Vermicompost Device for Domestic Use	28/07/2022	21/04/2023	Published
13.	Dr.P.T.Wankhedkar	Zoology	Glass to Identify the Quantity of Sugar and Calorie in Food	14/07/2022	31/03/2023	Published
14.	Dr.P.T.Wankhedkar	Zoology	Robotic Device For Pest Control in Farm	07/07/2022	20/01/2023	Published
15.	Dr.P.T.Wankhedkar	Zoology	IOT Enabled Device for Monitoring Oxygen and Blood Pressure in Human Body	07/05/2022	23/09/2022	Published
16.	Dr.P.T.Wankhedkar	Zoology	AI-Based Early Stage Detection and Prevention of Mental Deterioration and Incurable Brain Disease Using Image Processing in Heal Thecare Managment	27/04/2022	13/05/2022	Published
17.	Dr.P.T.Wankhedkar	Zoology	Device to Identify Content in The Mixture	07/04/2022	30/12/2022	Published
18.	Dr.P.T.Wankhedkar	Zoology	Honey Adulteration Testing Device	02/02/2022	29/04/2022	Published
19.	Dr.P.T.Wankhedkar	Zoology	Electrocardiogram Detecting Vest	03/01/2022	13/01/2023	Published
20.	Dr.N.R.Giri	Zoology	IOT Enabled	07/05/2022	23/09/2022	Published

Criterion III: Research, Innovations and Extension –

			Device for Monitoring Oxygen and Blood Pressure in Human Body			
21.	Dr.N.R.Giri	Zoology	Solar Powered Insect Drying Chamber	20/04/2022	14/10/2022	Published

3.2.1. Institution has created an ecosystem for innovations and has initiatives for creation and transfer of knowledge (patents filed, published, incubation center facilities in the HEI to be considered)

**List on Number of Teacher recognized as Research Guide: 2018-23 (Total Guide=4)**

Sr. No.	Name of the Teacher	Recognition for	Subject	Recognition Year
1.	Dr. A.S.Jondhale	Ph.D.	Botany	2021-22
2.	Dr. S. P. Chavan	Ph.D.	Botany	2021-22
3.	Dr.M.S.Shinde	Ph.D.	Physics	2021-22
4.	Dr. R.H.Wagachure	Ph.D.	Chemistry	2022-23

3.2.1. Institution has created an ecosystem for innovations and has initiatives for creation and transfer of knowledge (patents filed, published, incubation center facilities in the HEI to be considered)

**Data on number of Ph. Ds registered per eligible teacher within the year: 2018-23**

Number of research students registered per eligible teacher = 09

Sr. No.	Name of Ph.D. Scholar	Title of the thesis	Name of Dept.	Name of Guide	Year of Registration	Year of award of Ph.D.
1.	Miss.Surbhi Bhausheb Bhalerao	<i>In Vitro</i> Studies and Phytochemical Analysis of <i>Bacopa monnieri</i> (L.) Pennell	Botany	Dr.A.S.Jondhale	2022	--
2.	Mr.Bharat Trimbak Magar	Effective Potential Role of Aqueous Plant Extract Against	Botany	Dr.A.S.Jondhale	2022	--



Criterion III: Research, Innovations and Extension –

		Root Knot Nematode in Tomato Crop				
3.	Miss.Nisha Balu Suryawanshi	Phytochemical Screening and Green Synthesis of Silver Nanoparticles Using Leaf Extracts of <i>Malvastrum Coromandelianum</i> (L.) Garcke and <i>Berberis aristata</i> DC.	Botany	Dr.S.P.Chavan	2023	--
4.	Mr.Sagar Narayan Bhagwat		Botany	Dr.A.S.Jondhale	2023	
5.	Mr.Satyam Sham Bakare	Synthesis Characterization and Photocatalytic Applications of Transition and Non-transition Element Doped ZnO Nanomaterial for Dye Degradation	Chemistry	Dr.R.H.Waghch aure	2023	
6.	Mr.Abhinay Subash Mandawade	Synthesis of Vanadium Oxide Bismuth Oxide and Indium Oxide Nanostructure and their Applications in Gas Sensing and Photocatalytic Activity	Physics	Dr.M.S.Shinde	2022	
7.	Mr.Bhoye Laxman Namdeo	Studies on Gas Sensing Properties of Nanocrystalline Zirconium Dioxide and Nickel Oxide Thin Films	Physics	Dr.M.S.Shinde	2022	

Criterion III: Research, Innovations and Extension –

8.	Miss.Sonawane Laxmi Dilip	Synthesis of Cerium Oxide Silicon Oxide Nanostructures and their Applications in Gas Sensing and Photocatalytic Activity	Physics	Dr.M.S.Shinde	2022	
9.	Mr.Tayade Swapnil Santosh	SnO <sub>2</sub> based Nanostructured Semiconductor Sensitized Solar Cell	Physics	Dr.M.S.Shinde	2022	

पेटेंट कार्यालय  
शासकीय जर्नल

**OFFICIAL JOURNAL  
OF  
THE PATENT OFFICE**

निर्गमन सं. 32/2023  
ISSUE NO. 32/2023

शुक्रवार  
FRIDAY

दिनांक: 11/08/2023  
DATE: 11/08/2023

पेटेंट कार्यालय का एक प्रकाशन  
PUBLICATION OF THE PATENT OFFICE

The Patent Office Journal No. 32/2023 Dated 11/08/2023

52662

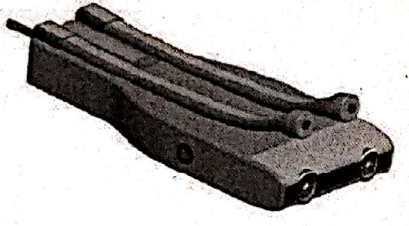
Design Number	386132-001	
Class	24-04	
<p>1. Ms. Pooja Ashok Suryawanshi Department of Zoology, Karm. A. M. Patil Arts, Commerce &amp; Kal. Annasaheb N. K. Patil. Science Sr. College, Pimpalner, Tal. Sakri, Dhule, Maharashtra-424306, India 2. Dr. Dhananjay Shivajirao Patil Assistant Professor, Department of Zoology, NTYS's G. T. Patil Arts, Commerce and Science College, Nandurbar, Maharashtra-425412, India 3. Dr. Sangeeta Bhimrao Dongre Department of Zoology, Government College of Arts and Science, Aurangabad, Maharashtra 431004 4. Dr. Prakash Tanaji Wankhedkar Assistant Professor, Department of Zoology, M.J.M. Arts, Commerce and Science College, Karanjali, Tal. Peth, Dist. Nashik- 422208, Maharashtra, India</p>		
Date of Registration	13/05/2023	
Title	NANOPARTICLE-BASED CANCER MEDICATION DEVICE	
Priority NA		



**INTELLECTUAL PROPERTY INDIA**  
 PATENTS INDIAN TRADE MARKS  
 GEOGRAPHICAL INDICATIONS



सत्यमेव जयते

ORIGINAL

क्रम सं/Serial No.: 141923



**पेटेंट कार्यालय, भारत सरकार**

**The Patent Office, Government Of India**

**डिजाइन के पंजीकरण का प्रमाण पत्र**

**Certificate of Registration of Design**

**डिजाइन सं./ Design No.**

**386132-001**

**तारीख / Date**

**13/05/2023**

**पारस्परिकता तारीख / Reciprocity Date**

**देश / Country**

**प्रमाणित किया जाता है कि संलग्न प्रति में वर्णित डिजाइन जो NANOPARTICLE-BASED CANCER**

**MEDICATION DEVICE** से संबंधित है, का पंजीकरण श्रेणी **24-04** में **1.Ms. Pooja Ashok**

**Suryawanshi 2. Dr. Dhananjay Shivajirao Patil 3. Dr. Sangeeta Bhimrao Dongre 4. Dr.**

**Prakash Tanaji Wankhedkar** के नाम में उपर्युक्त संख्या और तारीख में कर लिया गया है।

Certified that the design of which a copy is annexed hereto has been registered as of the number and date given above in class 24-04 in respect of the application of such design to **NANOPARTICLE-BASED CANCER MEDICATION DEVICE** in the name of:

**1.Ms. Pooja Ashok Suryawanshi 2. Dr. Dhananjay Shivajirao Patil 3. Dr. Sangeeta Bhimrao**

**Dongre 4. Dr. Prakash Tanaji Wankhedkar.**

**डिजाइन अधिनियम, 2000 तथा डिजाइन नियम, 2001 के अधधीन प्रावधानों के अनुरक्षण में।**  
**In pursuance of and subject to the provisions of the Designs Act, 2000 and the Designs Rules, 2001;**

**I.Q.A.C. Co-ordinator**  
**M.J.M. Arts, Commerce and Science College**  
**Keranjal, Nashik-422 208**

**Principal**  
**M.J.M. Arts, Commerce & Science College Karajali,**  
**Tal.Peth, Dist.Nashik**



**जारी करने की तिथि:**

**07/08/2023**

**महानियंत्रक पेटेंट डिजाइन और व्यापार चिह्न**  
**Controller General of Patents, Designs and Trade Marks**

\*पारस्परिकता तारीख (यदि कोई हो) जिसकी अनुमति दी गई है तथा देश का नाम। डिजाइन का स्वल्थिकार पंजीकरण की तारीख से दस वर्षों के लिए होगा जिसका विस्तार, अधिनियम एवं नियम के निर्बंधनों के अधीन, पांच वर्षों की अतिरिक्त अवधि के लिए किया जा सकेगा। इस प्रमाण पत्र का उपयोग विधिक कार्यवाहियों अथवा विदेश में पंजीकरण प्राप्त करने के लिए नहीं हो सकता है।  
 The reciprocity date (if any) which has been allowed and the name of the country. Copyright in the design will subsist for ten years from the date of Registration, and may under the terms of the Act and Rules, be extended for a further period of five years. This Certificate is not for use in legal proceedings or for obtaining registration abroad.

पेटेंट कार्यालय  
शासकीय जर्नल

**OFFICIAL JOURNAL  
OF  
THE PATENT OFFICE**

निर्गमन सं. 19/2023  
ISSUE NO. 19/2023

शुक्रवार  
FRIDAY

दिनांक: 12/05/2023  
DATE: 12/05/2023

पेटेंट कार्यालय का एक प्रकाशन  
PUBLICATION OF THE PATENT OFFICE

The Patent Office Journal No. 19/2023 Dated 12/05/2023

35597

Design Number	378216-001
Class	24-02
<p>1. Dr. Prakash Tanaji Wankhedkar Assistant Professor, Department of Zoology, M.J.M. Arts, Commerce and Science College, Karanjali, Tal. Peth, Dist. Nashik- 422208, Maharashtra, India 2. Prof. Priyanka Ramkrishna Narote Assistant Professor, M.G.V.S. College of Pharmacy, Nashik, Maharashtra, India 3. Dr. Prashant Kantilal Bagul Research Scholar, Department of Zoology, Karm. A.M. Patil Arts, Commerce and Science College, Pimpalner - 424306, Maharashtra, India 4. Mrs. Surekha Manojkumar Patil HOD Of Microbiology Department, Shikshan Maharshi Dadasaheb Limaye College - [SMDL], Navi Mumbai, Maharashtra, India. , et al.</p>	
Date of Registration	30/01/2023
Title	DEVICE TO IDENTIFY TYPE OF POISON IN BLOOD
Priority NA	

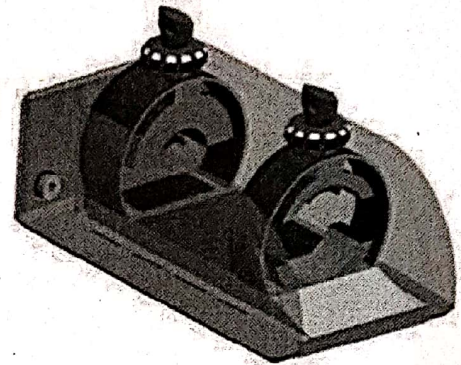

The Patent Office Journal No. 19/2023 Dated 12/05/2023

36757



ORIGINAL

मूल/No : 134683



भारत सरकार  
GOVERNMENT OF INDIA  
पेटेंट कार्यालय  
THE PATENT OFFICE

डिजाइन के पंजीकरण का प्रमाणपत्र  
CERTIFICATE OF REGISTRATION OF DESIGN

डिजाइन सं. / Design No. : 378216-001  
तारीख / Date : 30/01/2023  
पारस्परिकता तारीख / Reciprocity Date\* :  
देश / Country :

प्रमाणित किया जाता है कि संलग्न प्रति में वर्णित डिजाइन जो **DEVICE TO IDENTIFY TYPE OF POISON IN BLOOD** से संबंधित है, का पंजीकरण, श्रेणी 24-02 में 1.Dr. Prakash Tanaji Wankhedkar 2. Prof. Priyanka Ramkrishna Narote 3.Dr. Prashant Kantilal Bagul 4.Mrs. Surekha Manojkumar Patil 5.Mr. Parag Prakash Mahajan के नाम में उपर्युक्त संख्या और तारीख में कर लिया गया है।

Certified that the design of which a copy is annexed hereto has been registered as of the number and date given above in class 24-02 in respect of the application of such design to **DEVICE TO IDENTIFY TYPE OF POISON IN BLOOD** in the name of 1.Dr. Prakash Tanaji Wankhedkar 2. Prof. Priyanka Ramkrishna Narote 3.Dr. Prashant Kantilal Bagul 4.Mrs. Surekha Manojkumar Patil 5.Mr. Parag Prakash Mahajan.

डिजाइन अधिनियम, 2000 तथा डिजाइन नियम, 2001 के अधधीन प्रावधानों के अनुसरण में।  
In pursuance of and subject to the provisions of the Designs Act, 2000 and the Designs Rules, 2001.

INTELLECTUAL  
PROPERTY INDIA  
PATENTS IN DESIGNS TRADE MARKS  
GEOGRAPHICAL INDICATIONS

निर्गमन की तारीख/Date of Issue : 08/05/2023

  
महानियंत्रक पेटेंट डिजाइन और व्यापार चिह्न  
Controller General of Patents, Designs and Trade Marks

पारस्परिकता तारीख (यदि कोई हो) जिसकी अनुमति देश के नाम पर की गई है, डिजाइन का सत्ताधिकार पंजीकरण की तारीख से दस वर्षों के लिए होगा जिसका विस्तार, अधिनियम एवं नियम के निबंधनों के अधीन, पाँच वर्षों की अतिरिक्त अवधि के लिए किया जा सकता है। इस प्रमाण पत्र का उपयोग विधिक कार्यवाहियों अथवा विदेश में पंजीकरण प्राप्त करने के लिए नहीं हो सकता है।

\*The reciprocity date (if any) which has been allowed and the name of the country. Copyright in the design will subsist for ten years from the date of Registration, and may under the terms of the Act and Rules, be extended for a further period of five years. This Certificate is not for use in legal proceedings or for obtaining registration abroad.

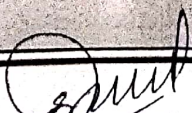
  
I.Q.A.C. Co-ordinator  
M.J.M. Arts, Commerce  
and Science College  
Karanjali, Nashik-422 208

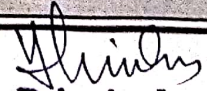
  
Principal  
M.J.M. Arts, Commerce &  
Science College Karajali,  
Tal. Peth. Dist. Nashik



पेटेंट कार्यालय  
शासकीय जर्नल

**OFFICIAL JOURNAL  
OF  
THE PATENT OFFICE**

निर्गमन सं. 09/2023  
ISSUE NO. 09/2023

शुक्रवार  
FRIDAY

दिनांक: 03/03/2023  
DATE: 03/03/2023

पेटेंट कार्यालय का एक प्रकाशन  
PUBLICATION OF THE PATENT OFFICE

The Patent Office Journal No. 09/2023 Dated 03/03/2023

13982

Design Number	374252-001
Class	24-02
<p>1. Dr. Prakash Tanaji Wankhedkar Assistant Professor, Department of Zoology, M.J.M. Arts, Commerce and Science College, Karanjali, Tal. Peth, Dist. Nashik-422208, India 2. Dr. Shaikh Hasim Mohammed Isak Assistant Professor, Head of Department of Zoology, Smt N.N.C. College Kusumba, Dhule-424302, India 3. Dr Sangeeta Bhimrao Dongre Assistant professor, Department of Zoology Government College of Arts and Science Aurangabad Maharashtra India 431001, India 4. Dr. Yusuf Ebrahim Patel Assistant Professor, Department of Zoology, Iqra Education Society's H. J. Thim College of Arts and Science Mehrun Jalgaon-425001, India , et al.</p>	
Date of Registration	16/11/2022
Title	INSULIN INJECTOR DEVICE
Priority NA	

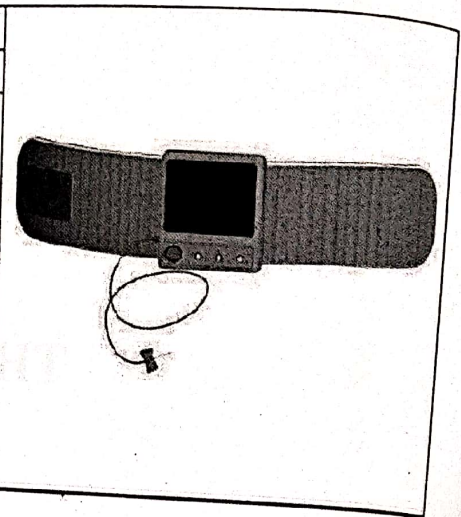

The Patent Office Journal No. 09/2023 Dated 03/03/2023

15017



ORIGINAL

मूल/No : 130123



भारत सरकार  
GOVERNMENT OF INDIA  
पेटेंट कार्यालय  
THE PATENT OFFICE  
डिजाइन के पंजीकरण का प्रमाणपत्र  
CERTIFICATE OF REGISTRATION OF DESIGN

डिजाइन सं. / Design No. : 374252-001  
तारीख / Date : 16/11/2022  
पारस्परिकता तारीख / Reciprocity Date\* :  
देश / Country :

प्रमाणित किया जाता है कि संलग्न प्रति में वर्णित डिजाइन जो **INSULIN INJECTOR DEVICE** से संबंधित है, का पंजीकरण, श्रेणी 24-02 में 1.Dr. Prakash Tanaji Wankhedkar 2. Dr. Shaikh Hasim Mohammed Isak 3.Dr Sangeeta Bhimrao Dongre 4.Dr. Yusuf Ebrahim Patel 5.Dr. Prashant Kantilal Bagul के नाम में उपर्युक्त संख्या और तारीख में कर लिया गया है।

Certified that the design of which a copy is annexed hereto has been registered as of the number and date given above in class 24-02 in respect of the application of such design to **INSULIN INJECTOR DEVICE** in the name of 1.Dr. Prakash Tanaji Wankhedkar 2. Dr. Shaikh Hasim Mohammed Isak 3.Dr Sangeeta Bhimrao Dongre 4.Dr. Yusuf Ebrahim Patel 5.Dr. Prashant Kantilal Bagul.

डिजाइन अधिनियम, 2000 तथा डिजाइन नियम, 2001 के अध्याधीन प्रावधानों के अनुसरण में।

In pursuance of and subject to the provisions of the Designs Act, 2000 and the Designs Rules, 2001.

INTELLECTUAL  
PROPERTY INDIA  
PATENTS, DESIGNS AND TRADE MARKS  
REGISTRATION AND INDICATION

निर्गमन की तारीख/Date of Issue : 02/03/2023

महानियंत्रक पेटेंट डिजाइन और व्यापार चिह्न  
Controller General of Patents, Designs and Trade Marks

पारस्परिकता तारीख (यदि कोई हो) जिसकी अनुमति देश के नाम पर की गई है। डिजाइन का सत्वाधिकार पंजीकरण की तारीख से दस वर्षों के लिए होगा जिसका विस्तार, अधिनियम एवं नियम के निर्बंधनों के अधीन, पांच वर्षों की अतिरिक्त अवधि के लिए किया जा सकता है। इस प्रमाण पत्र का उपयोग विधिक कार्यवाहियों अथवा विदेश में पंजीकरण प्राप्त करने के लिए नहीं हो सकता है।

\*The reciprocity date (if any) which has been allowed and the name of the country. Copyright in the design will subsist for ten years from the date of Registration, and may under the terms of the Act and Rules, be extended for a further period of five years. This Certificate is not for use in legal proceedings or for obtaining registration abroad.

I.Q.A.C. Co-ordinator  
M.J.M. Arts, Commerce  
and Science College  
Karajali, Nashik-422 208

Principal  
M.J.M. Arts, Commerce &  
Science College Karajali,  
Tal.Peth, Dist.Nashik



21 February 2023

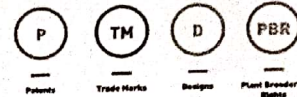

Delivering a world leading IP system

Phone: 1300 651 010  
International: +61 2 6283 2999

[www.ipaustralia.gov.au](http://www.ipaustralia.gov.au)

ABN: 38 113 072 755

# Registered design - examination not requested

**Dr. Prakash Tanaji Wankhedkar**

600 Glenferrie Rd  
Hawthorn VIC 3122  
Australia

**Design number**

202216726

**Owner name**

Dr. Prakash Tanaji Wankhedkar; Dr. Prashant Kantilal Bagul; Dr. Shaikh Hasim Mohammed Isak; Renuka Shivaji Bhamre; Uday Jatinbhai Thakkar

**Product name**

HEART ATTACK PREVENTING DEVICE

## Your progress

Dear Owner,

Your design was registered on 21 February 2023, and your Certificate of Registration is enclosed.

### What you can do

- **Have your design examined** - although your design has been registered, registration alone does not provide any enforceable rights. To be able to enforce this design it must be examined and if it meets our requirements a Certificate of Examination will be issued. You can submit a request for examination of your design using our [online services](#).

### Things to be aware of

- Your registration will last until 15 November 2027, at which time you will be able to renew.
- You cannot enforce your design until a Certificate of Examination has been issued.

Details of your design can be viewed on [Australian Design Search](#).

Yours sincerely,

IP Australia

- Filing**  
Application is assessed against the minimum requirements for filing
- Assessment**  
Application is assessed against the minimum requirements for registration (reported within 8 weeks from the request)
- Registration**  
Design is registered
- Examination (optional)**  
Registered design is examined (reported within 13 weeks from the request)
- Certification**  
Design is certified (making it legally enforceable)
- Renewal**  
Design is due for renewal (single renewal due at the 5th year)

**Need help?**

Visit our [website](#) for more information.  
You can also [chat with us online](#) from 9am – 5pm.  
We're here from Monday to Friday.  
If you're outside of these hours, [send us a message](#).





Australian Government

IP Australia

# CERTIFICATE OF REGISTRATION DESIGN

**Design number:** 202216726

The Registrar of Designs has registered the design represented on this certificate and certifies that the following particulars have been entered in the Register of Designs.

**Name and address of owner(s):**

Dr. Prakash Tanaji Wankhedkar of Assistant Professor, Department of Zoology M.J.M. Arts, Commerce and Science College Karanjali, Tal. Peth, Dist. Nashik Maharashtra 422208 India

Dr. Prashant Kantilal Bagul of Research Scholar Department of Zoology Karm. A.M. Patil Arts, Commerce and Science College, Pimpalner Maharashtra 424306 India

Dr. Shaikh Hasim Mohammed Isak of Assistant Professor Head of Department of Zoology Smt.N.N. C. College Kusumba Dhule Maharashtra 424302 India

Renuka Shivaji Bhamre of Parul institute of Pharmacy, Parul University Vadodara Gujarat India

Uday Jatinbhai Thakkar of Parul institute of Pharmacy, Parul University Vadodara Gujarat India

**Product to which the design is registered:**

HEART ATTACK PREVENTING DEVICE

**Name of designer(s):**

Dr. Prakash Tanaji Wankhedkar, Dr. Prashant Kantilal Bagul, Dr. Shaikh Hasim Mohammed Isak, Renuka Shivaji Bhamre and Uday Jatinbhai Thakkar

**Date of filing:**

15 November 2022

**Date of registration:**

21 February 2023

**Term of initial registration:**

Five years commencing on 15 November 2022

**Statement of newness and distinctiveness:**

The features of shape and Configuration of the HEART ATTACK PREVENTING DEVICE shown in the accompanying representations are considered to be new and distinctive.

NOTE: This Design Registration cannot be enforced unless and until it has been examined by the Registrar of Designs and a Certificate of Examination has been issued. See sections 73(3) and 77(3) of the Designs Act 2003, set out on the reverse of this document.



Dated this 21<sup>st</sup> day of February 2023

Registrar of Designs

## DESIGNS ACT 2003

The Australian Designs Register is the official record and should be referred to for the full details pertaining to this IP Right.



Australian Government

IP Australia

# CERTIFICATE OF REGISTRATION DESIGN

Design number: 202216726

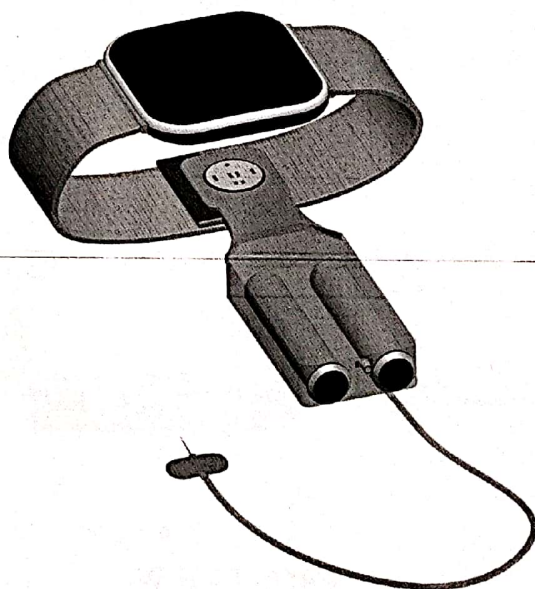

PERSPECTIVE VIEW

## DESIGNS ACT 2003

The Australian Designs Register is the official record and should be referred to for the full details pertaining to this IP Right.





Australian Government

IP Australia

# CERTIFICATE OF REGISTRATION DESIGN

Design number: 202216726

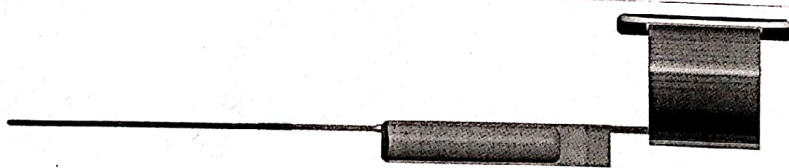

FRONT VIEW

## DESIGNS ACT 2003

The Australian Designs Register is the official record and should be referred to for the full details pertaining to this IP Right.



Australian Government

IP Australia

# CERTIFICATE OF REGISTRATION DESIGN

Design number: 202216726

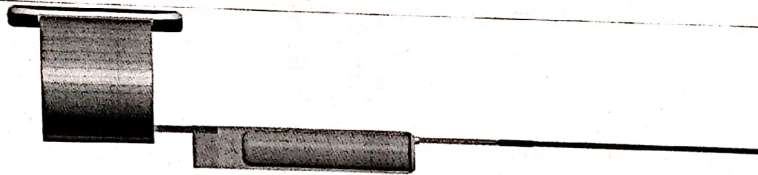

REAR VIEW

## DESIGNS ACT 2003

The Australian Designs Register is the official record and should be referred to for the full details pertaining to this IP Right.







Australian Government

IP Australia

# CERTIFICATE OF REGISTRATION DESIGN

Design number: 202216726

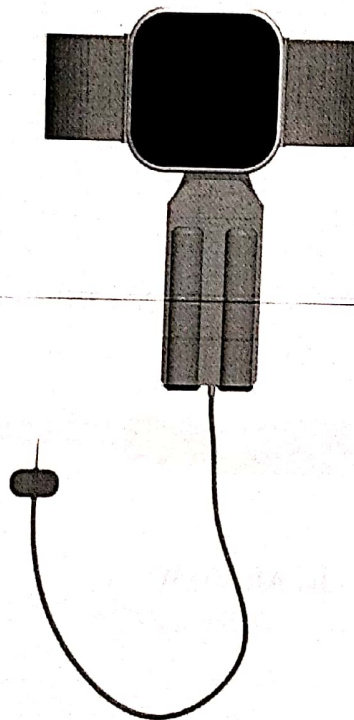

TOP VIEW

## DESIGNS ACT 2003

The Australian Designs Register is the official record and should be referred to for the full details pertaining to this IP Right.





Australian Government

IP Australia

# CERTIFICATE OF REGISTRATION DESIGN

Design number: 202216726

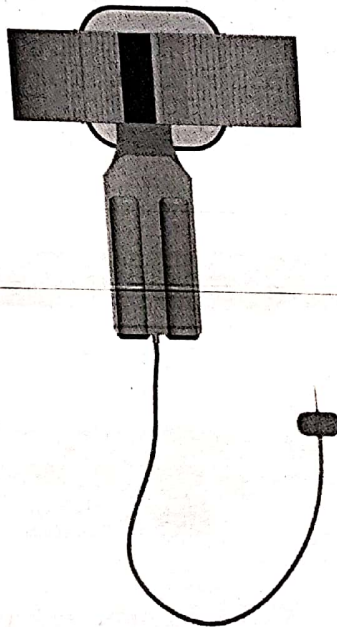

BOTTOM VIEW

## DESIGNS ACT 2003

The Australian Designs Register is the official record and should be referred to for the full details pertaining to this IP Right.





Australian Government

IP Australia

# CERTIFICATE OF REGISTRATION DESIGN

Design number: 202216726

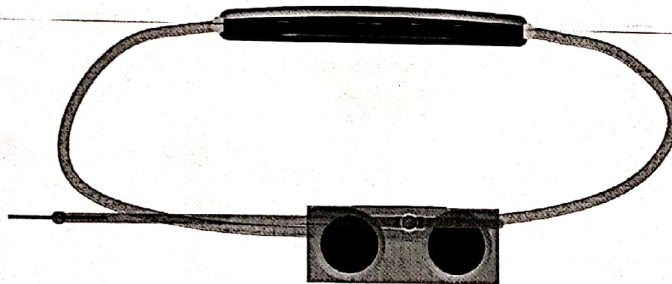

LEFT SIDE VIEW

## DESIGNS ACT 2003

The Australian Designs Register is the official record and should be referred to for the full details pertaining to this IP Right.



# CERTIFICATE OF REGISTRATION DESIGN

Design number: 202216726

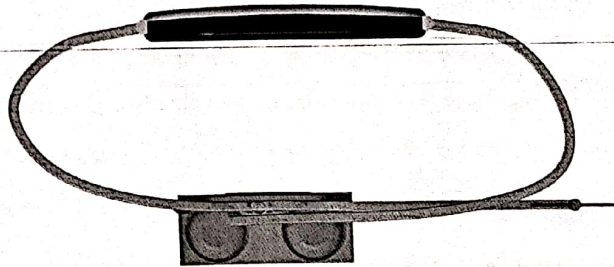

RIGHT SIDE VIEW

*[Faint, illegible text, possibly a signature or stamp]*

## DESIGNS ACT 2003

The Australian Designs Register is the official record and should be referred to for the full details pertaining to this IP Right.

Extracts from the Designs Act 2003

**Section 73**      **Infringement proceedings**

- (1) The registered owner of a registered design may bring proceedings against another person alleging that the person has infringed the registered design.
- (2) Infringement proceedings may be brought in a prescribed court or in another court that has jurisdiction in relation to the proceedings.
- (3) However, infringement proceedings may not be brought under subsection (1) until:
  - (a) the design has been examined under Chapter 5; and
  - (b) a certificate of examination has been issued.
- (4) If a person files an application under section 21 for registration of a design as a result of the operation of section 55, the person may only bring infringement proceedings in respect of infringements of the design occurring after the date on which the application was filed under section 21.

**Section 77**      **Application for relief from unjustified threats**

- (1) If a person is threatened by another person (the respondent) with infringement proceedings, or other similar proceedings, in respect of a design, an aggrieved person (the applicant) may apply to a prescribed court, or to another court that has jurisdiction to hear and determine the application, for:
  - (a) a declaration that the threats are unjustified; and
  - (b) an injunction against the continuation of the threats; and
  - (c) the recovery of damages sustained by the applicant as a result of the threats.
- (2) A threat mentioned in subsection (1) may be by means of circulars, advertisements or otherwise.
- (3) If a certificate of examination has not been issued in respect of a design, a threat to bring infringement proceedings, or other similar proceedings, in respect of the design is an unjustified threat for the purposes of this section.

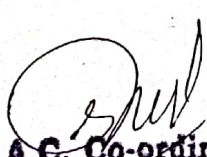
  
**L.Q.A.C. Co-ordinator**  
**M.J.M. Arts, Commerce**  
**and Science College**  
**Karanjali, Nashik-422 208**

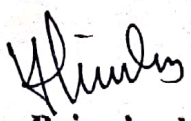
  
**Principal**  
**M.J.M. Arts, Commerce &**  
**Science College Karajali,**  
**Tal.Peth, Dist.Nashik**

पेटेंट कार्यालय  
शासकीय जर्नल

**OFFICIAL JOURNAL  
OF  
THE PATENT OFFICE**

निर्गमन सं. 05/2023  
ISSUE NO. 05/2023

शुक्रवार  
FRIDAY

दिनांक: 03/02/2023  
DATE: 03/02/2023

पेटेंट कार्यालय का एक प्रकाशन  
PUBLICATION OF THE PATENT OFFICE

The Patent Office Journal No. 05/2023 Dated 03/02/2023

7843

Design Number	375031-001	
Class	10-05	
<b>1. Mr. Govind Dnyanoba Bhendekar PhD Scholar, Department of Zoology, Savitribai Phule Pune University, Pune 2. Miss. Neeraja Pravin Dhole PhD scholar, Department of Zoology, Savitribai Phule Pune University, Pune 3. Dr. Prakash Tanaji Wankhedkar Assistant Professor, Department of Zoology, M.J.M. Arts, Commerce and Science College, Karanjali, Tal. Peth, Dist. Nashik- 422208, India</b>		
Date of Registration	03/12/2022	
Title	DEVICE TO IDENTIFY ANIMAL STRESS	
Priority NA		



ORIGINAL

मूल/No : 128346



भारत सरकार  
GOVERNMENT OF INDIA  
पेटेंट कार्यालय  
THE PATENT OFFICE  
डिजाइन के पंजीकरण का प्रमाणपत्र  
CERTIFICATE OF REGISTRATION OF DESIGN

डिजाइन सं. / Design No. : 375031-001  
तारीख / Date : 03/12/2022  
पारस्परिकता तारीख / Reciprocity Date\* :  
देश / Country :

प्रमाणित किया जाता है कि संलग्न प्रति में वर्णित डिजाइन जो **DEVICE TO IDENTIFY ANIMAL STRESS** से संबंधित है, का पंजीकरण, श्रेणी 10-05 में 1.Mr. Govind Dnyanoba Bhendekar 2. Miss. Neeraja Pravin Dhole 3.Dr. **Prakash Tanaji Wankhedkar** के नाम में उपर्युक्त संख्या और तारीख में कर लिया गया है।

Certified that the design of which a copy is annexed hereto has been registered as of the number and date given above in class 10-05 in respect of the application of such design to **DEVICE TO IDENTIFY ANIMAL STRESS** in the name of 1.Mr. Govind Dnyanoba Bhendekar 2. Miss. Neeraja Pravin Dhole 3.Dr. **Prakash Tanaji Wankhedkar**.

डिजाइन अधिनियम, 2000 तथा डिजाइन नियम, 2001 के अधधीन प्रावधानों के अनुसरण में।

In pursuance of and subject to the provisions of the Designs Act, 2000 and the Designs Rules, 2001.

INTELLECTUAL  
PROPERTY INDIA  
PATENTS | DESIGNS | TRADE MARKS  
GEOGRAPHICAL INDICATIONS

निर्गमन की तारीख/Date of Issue : 02/02/2023

  
महानियंत्रक पेटेंट डिजाइन और व्यापार चिह्न  
Controller General of Patents, Designs and Trade Marks

पारस्परिकता तारीख (यदि कोई हो) जिसकी अनुमति देश के नाम पर की गई है। डिजाइन का सन्नाधिकार पंजीकरण की तारीख से दस वर्षों के लिए होगा जिसका विस्तार, अधिनियम एवं नियम के निबंधनों के अधीन, पांच वर्षों की अतिरिक्त अवधि के लिए किया जा सकता है। इस प्रमाण पत्र का उपयोग विधिक कार्यवाहियों अथवा विदेश में पंजीकरण प्राप्त करने के लिए नहीं हो सकता है।

\*The reciprocity date (if any) which has been allowed and the name of the country. Copyright in the design will subsist for ten years from the date of Registration, and may under the terms of the Act and Rules, be extended for a further period of five years. This Certificate is not for use in legal proceedings or for obtaining registration abroad.

  
I.Q.A.C. Co-ordinator  
M.J.M. Arts, Commerce  
and Science College  
Karanjali, Nashik-422 208

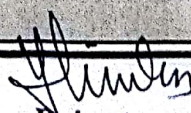
  
Principal  
M.J.M. Arts, Commerce &  
Science College Karajali,  
Tal. Peth, Dist. Nashik



पेटेंट कार्यालय  
शासकीय जर्नल

**OFFICIAL JOURNAL  
OF  
THE PATENT OFFICE**

निर्गमन सं. 05/2023  
ISSUE NO. 05/2023

शुक्रवार  
FRIDAY

दिनांक: 03/02/2023  
DATE: 03/02/2023

पेटेंट कार्यालय का एक प्रकाशन  
PUBLICATION OF THE PATENT OFFICE

The Patent Office Journal No. 05/2023 Dated 03/02/2023

7843

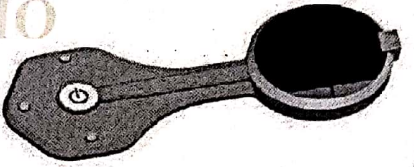
Design Number	375715-001	
Class	24-02	
<b>1. Dr. Dhananjay Shivajirao Patil Assistant Professor, Department of Zoology, NTVS's G. T. Patil Arts, Commerce and Science College, Nandurbar, Maharashtra-425412, India 2. Dr. Prakash Tanaji Wankhedkar Assistant Professor, Department of Zoology, M.J.M. Arts, Commerce and Science College, Karanjali, Tal. Peth, Dist. Nashik- 422208, Maharashtra, India. 3. Dr. Sangeeta Bhimrao Dongre Flat No. 4, Ashrivad Heights, Shivtej Nagar, Shridhar Colony, Near Datt Temple, Peth Road, Nashik PIN 422004, India</b>		
Date of Registration	16/12/2022	
Title	<b>DEVICE TO DETECT DRUG RESISTANCE</b>	
Priority NA		

375715-001

24-02

16/12/2022



ORIGINAL

मूल/No : 128252



भारत सरकार  
GOVERNMENT OF INDIA  
पेटेंट कार्यालय  
THE PATENT OFFICE

डिजाइन के पंजीकरण का प्रमाणपत्र  
CERTIFICATE OF REGISTRATION OF DESIGN

डिजाइन सं. / Design No. : 375715-001  
तारीख / Date : 16/12/2022  
पारस्परिकता तारीख / Reciprocity Date\* :  
देश / Country :

प्रमाणित किया जाता है कि संलग्न प्रति में वर्णित डिजाइन जो **DEVICE TO DETECT DRUG RESISTANCE** से संबंधित है, का पंजीकरण, श्रेणी 24-02 में 1. Dr. Dhananjay Shivajirao Patil 2. Dr. Prakash Tanaji Wankhedkar 3. Dr. Sangeeta Bhimrao Dongre के नाम में उपर्युक्त संख्या और तारीख में कर लिया गया है।

Certified that the design of which a copy is annexed hereto has been registered as of the number and date given above in class 24-02 in respect of the application of such design to **DEVICE TO DETECT DRUG RESISTANCE** in the name of 1. Dr. Dhananjay Shivajirao Patil 2. Dr. Prakash Tanaji Wankhedkar 3. Dr. Sangeeta Bhimrao Dongre.

डिजाइन अधिनियम, 2000 तथा डिजाइन नियम, 2001 के अध्याधीन प्रावधानों के अनुसरण में।

In pursuance of and subject to the provisions of the Designs Act, 2000 and the Designs Rules, 2001.

INTELLECTUAL PROPERTY  
INDIA  
PATENTS, DESIGNS, TRADE MARKS  
BIOGRAPHICAL INDICATIONS

निर्गमन की तारीख/Date of Issue : 01/02/2023

महानियंत्रक पेटेंट डिजाइन और व्यापार चिह्न  
Controller General of Patents, Designs and Trade Marks

पारस्परिकता तारीख (यदि कोई हो) जिसकी अनुमति देश के नाम पर की गई है। डिजाइन का सत्वाधिकार पंजीकरण की तारीख से दस वर्षों के लिए होगा जिसका विस्तार, अधिनियम एवं नियम के निबंधनों के अधीन, पाँच वर्षों की अतिरिक्त अवधि के लिए किया जा सकेगा। इस प्रमाण पत्र का उपयोग विधिक कार्यवाहियों अथवा विदेश में पंजीकरण प्राप्त करने के लिए नहीं हो सकता है।  
\*The reciprocity date (if any) which has been allowed and the name of the country. Copyright in the design will subsist for ten years from the date of Registration, and may under the terms of the Act and Rules, be extended for a further period of five years. This Certificate is not for use in legal proceedings or for obtaining registration abroad.

L.Q.A.C. Co-ordinator  
M.J.M. Arts, Commerce  
and Science College  
Karanjali, Nashik-422 208

Principal  
M.J.M. Arts, Commerce &  
Science College Karajali,  
Tal. Peth, Dist. Nashik

**G पेटेंट कार्यालय  
शासकीय जर्नल**

**OFFICIAL JOURNAL  
OF  
THE PATENT OFFICE**

**निर्गमन सं. 04/2023  
ISSUE NO. 04/2023**

**शुक्रवार  
FRIDAY**

**दिनांक: 27/01/2023  
DATE: 27/01/2023**

**पेटेंट कार्यालय का एक प्रकाशन  
PUBLICATION OF THE PATENT OFFICE**

The Patent Office Journal No. 04/2023 Dated 27/01/2023

6113

पत० ३३५०

Design Number	375714-001	
Class	24-01	
1. Dr. Sangeeta Bhimrao Dongre Assistant Professor, Department of Zoology Government College of Arts and Science Aurangabad Maharashtra -431001, India 2. Dr. Dhananjay Shivajirao Patil Assistant Professor, Department of Zoology, NTVS's G. T. Patil Arts, Commerce and Science College, Nandurbar, Maharashtra-425412, India 3. Dr. Prakash Tanaji Wankhedkar Assistant Professor, Department of Zoology, M.J.M. Arts, Commerce and Science College, Karanjali, Tal. Peth, Dist. Nashik- 422208, Maharashtra, India.		
Date of Registration	16/12/2022	
Title	DEVICE TO DETECT HEMOSTATIC FUNCTION IN ANIMALS	
Priority NA		



ORIGINAL

मूल/No : 127411



भारत सरकार  
GOVERNMENT OF INDIA  
पेटेंट कार्यालय  
THE PATENT OFFICE  
डिजाइन के पंजीकरण का प्रमाणपत्र  
CERTIFICATE OF REGISTRATION OF DESIGN

डिजाइन सं. / Design No. : 375714-001  
तारीख / Date : 16/12/2022  
पारस्परिकता तारीख / Reciprocity Date\* :  
देश / Country :

प्रमाणित किया जाता है कि संलग्न प्रति में वर्णित डिजाइन जो **DEVICE TO DETECT HEMOSTATIC FUNCTION IN ANIMALS** से संबंधित है, का पंजीकरण, श्रेणी 24-01 में 1.Dr. Sangeeta Bhimrao Dongre 2. Dr. Dhananjay Shivajirao Patil 3.Dr. Prakash Tanaji Wankhedkar के नाम में उपर्युक्त संख्या और तारीख में कर लिया गया है।

Certified that the design of which a copy is annexed hereto has been registered as of the number and date given above in class 24-01 in respect of the application of such design to **DEVICE TO DETECT HEMOSTATIC FUNCTION IN ANIMALS** in the name of 1.Dr. Sangeeta Bhimrao Dongre 2. Dr. Dhananjay Shivajirao Patil 3.Dr. Prakash Tanaji Wankhedkar.

डिजाइन अधिनियम, 2000 तथा डिजाइन नियम, 2001 के अध्याधीन प्रावधानों के अनुसरण में।

In pursuance of and subject to the provisions of the Designs Act, 2000 and the Designs Rules, 2001.

INTELLECTUAL  
PROPERTY INDIA  
PATENTS, DESIGNS, TRADE MARKS  
GEOGRAPHICAL INDICATIONS

निर्गमन की तारीख/Date of Issue : 25/01/2023

  
महानिर्देशक पेटेंट-डिजाइन और व्यापार चिह्न  
Controller General of Patents, Designs and Trade Marks

पारस्परिकता तारीख (यदि कोई हो) जिसकी अनुमति देश के नाम पर की गई है। डिजाइन का सत्वाधिकार पंजीकरण की तारीख से दस वर्षों के लिए होगा जिसका विस्तार, अधिनियम एवं नियम के निबंधनों के अधीन, पाँच वर्षों की अतिरिक्त अवधि के लिए किया जा सकेगा। इस प्रमाण पत्र का उपयोग विधिक कार्यवाहियों अथवा विदेश में पंजीकरण प्राप्त करने के लिए नहीं हो सकता है।

\*The reciprocity date (if any) which has been allowed and the name of the country. Copyright in the design will subsist for ten years from the date of Registration, and may under the terms of the Act and Rules, be extended for a further period of five years. This Certificate is not for use in legal proceedings or for obtaining registration abroad.

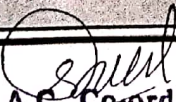
  
I.Q.A.C. Co-ordinator  
M.J.M. Arts, Commerce  
and Science College  
Karanjall, Nashik-422 208

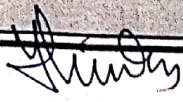
  
Principal  
M.J.M. Arts, Commerce &  
Science College Karajali,  
Tal.Peth, Dist.Nashik

पेटेंट कार्यालय  
शासकीय जर्नल

**OFFICIAL JOURNAL  
OF  
THE PATENT OFFICE**

निर्गमन सं. 52/2022  
ISSUE NO. 52/2022

शुक्रवार  
FRIDAY

दिनांक: 30/12/2022  
DATE: 30/12/2022

पेटेंट कार्यालय का एक प्रकाशन  
PUBLICATION OF THE PATENT OFFICE

The Patent Office Journal No. 52/2022 Dated 30/12/2022

81504

(12) PATENT APPLICATION PUBLICATION

(21) Application No. 202221069895 A

(19) INDIA

(22) Date of filing of Application : 04/12/2022

(43) Publication Date : 30/12/2022

(54) Title of the invention : SYSTEM TO ASSESS AND IDENTIFY THE CASUALTY OF THE WOUND TISSUE USING ARTIFICIAL INTELLIGENCE

(51) International classification : A61B0005000000, G06N0020000000, A61P0017020000,  
 (86) International Application No : G06T0007000000, G06T0007110000  
 Filing Date : NA  
 (87) International Publication No : NA  
 (61) Patent of Addition to Application Number : NA  
 Filing Date : NA  
 (62) Divisional to Application Number : NA  
 Filing Date : NA

(71) Name of Applicant :  
 1) Sumit Kumar Roy  
 Address of Applicant : MIG-66, Sector-2, Shankar Nagar, Raipur Chhattisgarh 492001  
 2) Dr. Hitendra Kumar Lantre  
 3) Dr. Prakash Tanaji Wankhedkar  
 4) Dr. Kiranpal Singh Virk  
 5) Dr. Ramakrishnan Raman  
 6) Mrs. Kanchan Sudhir Gorde  
 7) R. Meenakshi  
 8) Dr. Pankaj Dadheech  
 9) Dr. Pallab Kalita  
 10) Ruhul Amin  
 Name of Applicant : NA  
 Address of Applicant : NA  
 (72) Name of Inventor :  
 1) Sumit Kumar Roy  
 Address of Applicant : MIG-66, Sector-2, Shankar Nagar, Raipur Chhattisgarh 492001  
 2) Dr. Hitendra Kumar Lantre  
 Address of Applicant : BYOS SCIENTIFIC LAB, Mowa, Raipur Chhattisgarh 492007  
 3) Dr. Prakash Tanaji Wankhedkar  
 Address of Applicant : Assistant Professor, Department of Zoology, M.J.M. ACS College, Karanjali, Tal. Peth, Dist. Nashik - 422208  
 4) Dr. Kiranpal Singh Virk  
 Address of Applicant : Assistant Professor, Department of Computer Science, Guru Nanak Khalsa College, Yamuna Nagar, Haryana  
 5) Dr. Ramakrishnan Raman  
 Address of Applicant : Professor and Director, Symbiosis Institute of Business Management and Symbiosis International (Deemed University), Pune, Maharashtra, India  
 6) Mrs. Kanchan Sudhir Gorde  
 Address of Applicant : Assistant Professor Department of Electronics Engineering Terna Engineering College Nerul, Navi Mumbai 400708  
 7) R. Meenakshi  
 Address of Applicant : Professor, Department of CSE, Chennai institute of technology  
 8) Dr. Pankaj Dadheech  
 Address of Applicant : Associate Professor, Department of Computer Science & Engineering (NBA Accredited), Swami Keshvanand Institute of Technology, Management & Gramothan (SKIT), Jaipur, Rajasthan-302017, India  
 9) Dr. Pallab Kalita  
 Address of Applicant : Principal cum Associate Professor School of Pharmaceutical Sciences, University of Science and Technology Meghalaya, Baridua, Ribhoi, 793101, Meghalaya  
 10) Ruhul Amin  
 Address of Applicant : Assistant Professor Faculty of Pharmaceutical Science, Assam down town University, Panikhati, Guwahati- 781026

(57) Abstract :  
 This invention describes a wound analysing and treating system with a machine-learning-based approach for automated analysis of wound tissue from optical coherence tomography images. The process applies to all types of wounds, requires no manual input, and can produce clinically relevant metrics for the assessment of wound healing. The method addresses the need for automating and enriching the assessment of wounds and wound healing for improved monitoring of patients suffering from chronic injuries. This machine learning model will help identify and locate different tissue compartments present within a wound at variable depths previously not identified. It is directed to treat various forms of breaks in skin tissue and chronic surface tissue wounds.

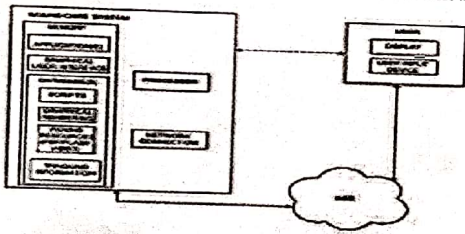

FIGURE - 1

No. of Pages : 20 No. of Claims : 9

The Patent Office Journal No. 52/2022 Dated 30/12/2022

82329

*[Signature]*  
**Principal**  
 M.J.M. Arts, Commerce  
 and Science College  
 Karanjali, Nashik-422 208

*[Signature]*  
**I.Q.A.C. Co-ordinator**  
 M.J.M. Arts, Commerce  
 and Science College  
 Karanjali, Nashik-422 208





28 October 2022

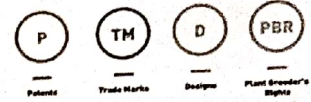

Delivering a world leading IP system

Phone: 1300 651 010  
International: +61 2 6283 2999

[www.ipaustralia.gov.au](http://www.ipaustralia.gov.au)

ABN: 38 113 072 755

# Registered design - examination not requested

**Dr. Prakash Tanaji Wankhedkar**  
600 Glenferrie Rd  
Hawthorn VIC 3122  
Australia

<b>Design number</b>	202215235
<b>Owner name</b>	Dr. Prakash Tanaji Wankhedkar; Dr. Shaikh Hasim Mohammed Isak; Dr. Sangeeta Bhimrao Dongre; Dr. Yusuf Ebrahim Patel; Dr. Prashant Kantilal Bagul
<b>Product name</b>	INSULIN INJECTING DEVICE

## Your progress

Dear Owner,

Your design was registered on 25 October 2022, and your Certificate of Registration is enclosed.

### What you can do

- **Have your design examined** - although your design has been registered, registration alone does not provide any enforceable rights. To be able to enforce this design it must be examined and if it meets our requirements a Certificate of Examination will be issued. You can submit a request for examination of your design using our [online services](#).

### Things to be aware of

- Your registration will last until 2 September 2027, at which time you will be able to renew.
- You cannot enforce your design until a Certificate of Examination has been issued.

Details of your design can be viewed on [Australian Design Search](#).

Yours sincerely,

IP Australia

- Filing**  
Application is assessed against the minimum requirements for filing
- Assessment**  
Application is assessed against the minimum requirements for registration (reported within 8 weeks from the request)
- Registration**  
Design is registered
- Examination (optional)**  
Registered design is examined (reported within 13 weeks from the request)
- Certification**  
Design is certified (making it legally enforceable)
- Renewal**  
Design is due for renewal (single renewal due at the 5th year)

## Need help?

Talk to Alex, our virtual assistant



For further information on this topic, visit our [website](#).

Make an enquiry or provide feedback on our [website](#).





Australian Government  
IP Australia

# CERTIFICATE OF REGISTRATION DESIGN

Design number: 202215235

The Registrar of Designs has registered the design represented on this certificate and certifies that the following particulars have been entered in the Register of Designs.

**Name and address of owner(s):**

Dr. Prakash Tanaji Wankhedkar of Assistant Professor, Department of Zoology M.J.M. Arts, Commerce and Science College Karanjali, Tal. Peth, Dist. Nashik Maharashtra 422208 India

Dr. Shaikh Hasim Mohammed Isak of Assistant Professor Head of Department of Zoology Smt.N.N. C. College Kusumba Dhule Maharashtra 424302 India

Dr Sangeeta Bhimrao Dongre of Assistant professor Department of Zoology Government College of Arts and Science Aurangabad Maharashtra 431001 India

Dr. Yusuf Ebrahim Patel of Assistant Professor Department of Zoology Iqra Education Society's H. J. Thim College of Arts and Science Mehrun Jalgaon Maharashtra 425001 India

Dr. Prashant Kantilal Bagul of Research Scholar Department of Zoology Karm. A.M. Patil Arts, Commerce and Science College, Pimpalner Maharashtra 424306 India

**Product to which the design is registered:**

INSULIN INJECTING DEVICE

**Name of designer(s):**

Dr. Prakash Tanaji Wankhedkar, Dr. Shaikh Hasim Mohammed Isak, Dr Sangeeta Bhimrao Dongre, Dr. Yusuf Ebrahim Patel and Dr. Prashant Kantilal Bagul

**Date of filing:**

2 September 2022

**Date of registration:**

25 October 2022

**Term of initial registration:**

Five years commencing on 2 September 2022

**Statement of newness and distinctiveness:**

The features of Shape and Configuration of the INSULIN INJECTING DEVICE shown in the accompanying representations are considered to be new and distinctive.

NOTE: This Design Registration cannot be enforced unless and until it has been examined by the Registrar of Designs and a Certificate of Examination has been issued. See sections 73(3) and 77(3) of the Designs Act 2003, set out on the reverse of this document.



Dated this 28<sup>th</sup> day of October 2022

Registrar of Designs

## DESIGNS ACT 2003

The Australian Designs Register is the official record and should be referred to for the full details pertaining to this IP Right.



Australian Government

IP Australia

# CERTIFICATE OF REGISTRATION DESIGN

Design number: 202215235

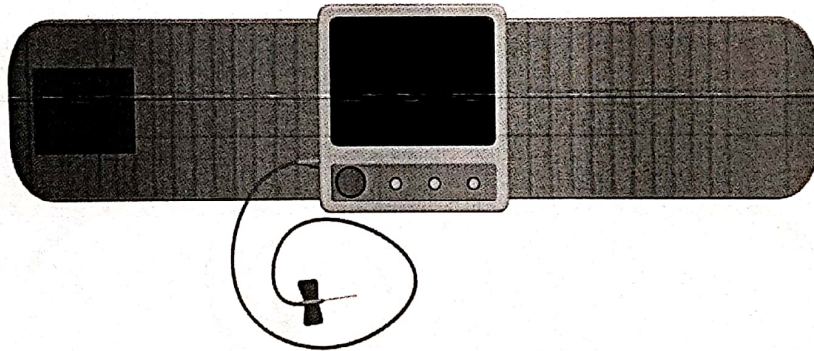

FRONT VIEW

## DESIGNS ACT 2003

The Australian Designs Register is the official record and should be referred to for the full details pertaining to this IP Right.





Australian Government

IP Australia

# CERTIFICATE OF REGISTRATION DESIGN

Design number: 202215235

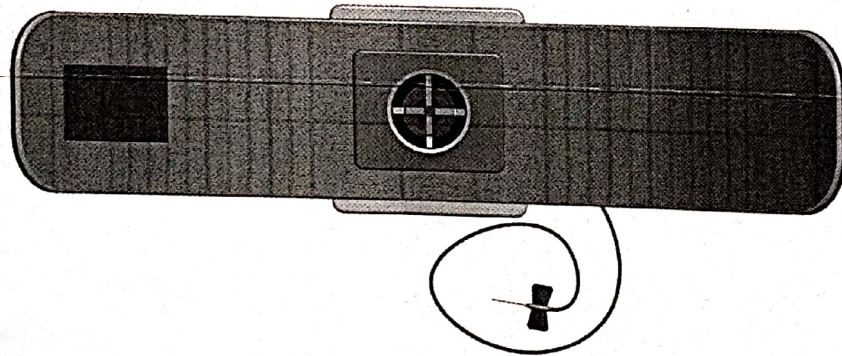

REAR VIEW

## DESIGNS ACT 2003

The Australian Designs Register is the official record and should be referred to for the full details pertaining to this IP Right.



Australian Government

IP Australia

# CERTIFICATE OF REGISTRATION DESIGN

Design number: 202215235

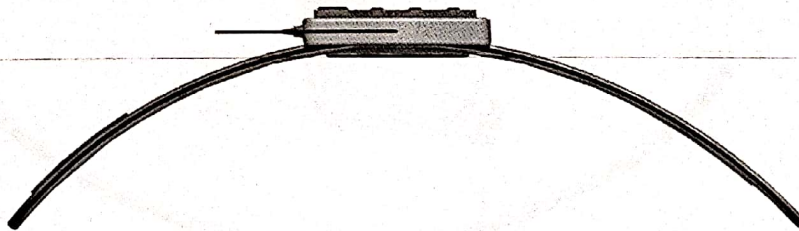

## DESIGNS ACT 2003

The Australian Designs Register is the official record and should be referred to for the full details pertaining to this IP Right.





Australian Government

IP Australia

# CERTIFICATE OF REGISTRATION DESIGN

Design number: 202215235

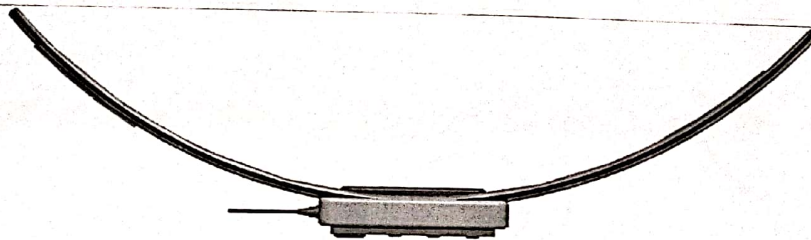

TOP VIEW

## DESIGNS ACT 2003

The Australian Designs Register is the official record and should be referred to for the full details pertaining to this IP Right.





Australian Government

IP Australia

# CERTIFICATE OF REGISTRATION DESIGN

Design number: 202215235

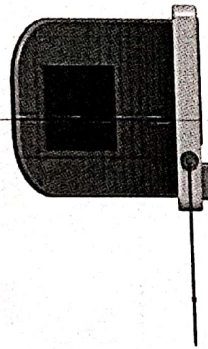

LEFT SIDE VIEW

## DESIGNS ACT 2003

The Australian Designs Register is the official record and should be referred to for the full details pertaining to this IP Right.





Australian Government

IP Australia

# CERTIFICATE OF REGISTRATION DESIGN

Design number: 202215235

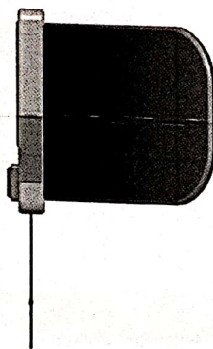

RIGHT SIDE VIEW

## DESIGNS ACT 2003

The Australian Designs Register is the official record and should be referred to for the full details pertaining to this IP Right.





# CERTIFICATE OF REGISTRATION DESIGN

Design number: 202215235

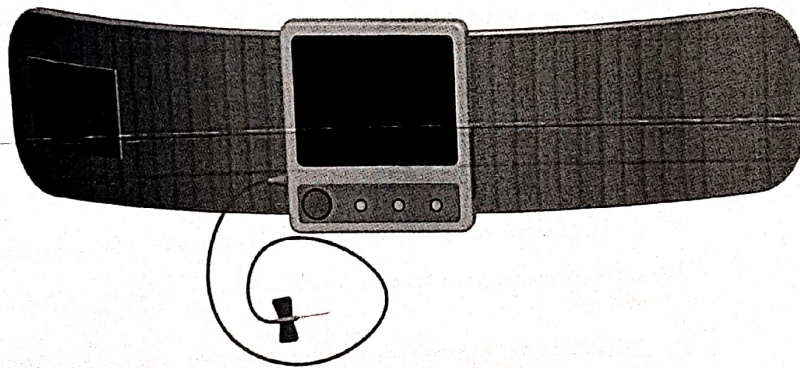

PERSPECTIVE VIEW

*[Faint, illegible text, possibly a signature or stamp]*

## DESIGNS ACT 2003

The Australian Designs Register is the official record and should be referred to for the full details pertaining to this IP Right.

Extracts from the Designs Act 2003

**Section 73      Infringement proceedings**

- (1) The registered owner of a registered design may bring proceedings against another person alleging that the person has infringed the registered design.
- (2) Infringement proceedings may be brought in a prescribed court or in another court that has jurisdiction in relation to the proceedings.
- (3) **However, infringement proceedings may not be brought under subsection (1) until:**
  - (a) the design has been examined under Chapter 5; and
  - (b) a certificate of examination has been issued.
- (4) If a person files an application under section 21 for registration of a design as a result of the operation of section 55, the person may only bring infringement proceedings in respect of infringements of the design occurring after the date on which the application was filed under section 21.

**Section 77      Application for relief from unjustified threats**

- (1) If a person is threatened by another person (the respondent) with infringement proceedings, or other similar proceedings, in respect of a design, an aggrieved person (the applicant) may apply to a prescribed court, or to another court that has jurisdiction to hear and determine the application, for:
  - (a) a declaration that the threats are unjustified; and
  - (b) an injunction against the continuation of the threats; and
  - (c) the recovery of damages sustained by the applicant as a result of the threats.
- (2) A threat mentioned in subsection (1) may be by means of circulars, advertisements or otherwise.
- (3) **If a certificate of examination has not been issued in respect of a design, a threat to bring infringement proceedings, or other similar proceedings, in respect of the design is an unjustified threat for the purposes of this section.**

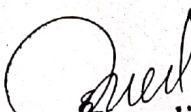
  
**I.Q.A.C. Co-ordinator**  
M.J.M. Arts, Commerce  
and Science College  
Kerajali, Nashik-422 208

  
**Principal**  
M.J.M. Arts, Commerce &  
Science College Karajali,  
Tal.Peth, Dist.Nashik

पेटेंट कार्यालय  
शासकीय जर्नल

**OFFICIAL JOURNAL  
OF  
THE PATENT OFFICE**

निर्गमन सं. 51/2022

ISSUE NO. 51/2022

शुक्रवार



FRIDAY

दिनांक: 23/12/2022

DATE: 23/12/2022

The Patent Office Journal No. 51/2022 Dated 23/12/2022

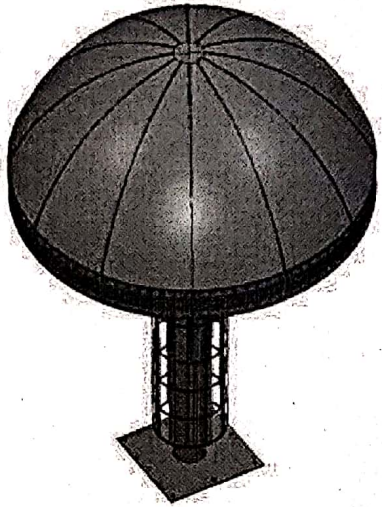
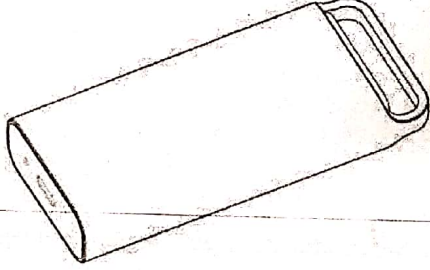
80203

Design Number	368719-001		
Class	11-04		
Mr. Subhash Motilal Pawar A/3703, Tirumala Habitats, Balrajeshwar mandir Road, Off LBS Marg, Mulund West, Mumbai, Mumbai Suburban, Maharashtra-400080			
Date of Registration	03/08/2022		
Title	Illuminated Artificial Tree		
Priority NA			
Design Number	368730-001		
Class	14-05		
SAMSUNG ELECTRONICS CO., LTD. 129, Samsung-ro, Yeongtong-gu, Suwon-si, Gyeonggi-do, Republic of Korea			
Date of Registration	03/08/2022		
Title	SSD(SOLID STATE DRIVE) MEMORY DEVICE		
Priority			
Priority Number	Date	Country	
30-2022-0019520	17/05/2022	Republic of Korea	
Design Number	368750-001		
Class	10-05		
1. Dr. Shaikh Hasim Mohammed Isak Assistant Professor, Head of Department of Zoology, Smt. N.N.C. College, Kusumba., Dhule - 424302 2. Dr. Prakash Tanaji Wankhedkar Assistant Professor, Department of Zoology, M.J.M. ACS College, Karanjali, Tal. Peth, Dist. Nashik - 422208 3. Mr. Siddharth Dnyandeo Nimbalkar Assistant professor, Department of Electronic Science, RNC Arts, JDB Commerce & NSC Science College Nasik road, Nasik - 422101 4. Dr. Patel Yusuf Ebrahim Assistant Professor, Department of Zoology, Iqra Education Society's H. J. Thim College of Arts and Science Mehrun Jalgaon - 425001			
Date of Registration	04/08/2022		
Title	BIRD NEST MONITORING DEVICE		
Priority NA			



ORIGINAL

मूल/No : 121170



भारत सरकार  
GOVERNMENT OF INDIA  
पेटेंट कार्यालय  
THE PATENT OFFICE  
डिजाइन के पंजीकरण का प्रमाणपत्र  
CERTIFICATE OF REGISTRATION OF DESIGN

डिजाइन सं. / Design No. : 368750-001  
तारीख / Date : 04/08/2022  
पारस्परिकता तारीख / Reciprocity Date\* :  
देश / Country :

प्रमाणित किया जाता है कि संलग्न प्रति में वर्णित डिजाइन जो **BIRD NEST MONITORING DEVICE** से संबंधित है, का पंजीकरण, श्रेणी 10-05 में 1.Dr. Shaikh Hasim Mohammed Isak 2. Dr. Prakash Tanaji Wankhedkar 3.Mr. Siddharth Dnyandeo Nimbalkar 4.Dr. Patel Yusuf Ebrahim के नाम में उपर्युक्त संख्या और तारीख में कर लिया गया है।

Certified that the design of which a copy is annexed hereto has been registered as of the number and date given above in class 10-05 in respect of the application of such design to **BIRD NEST MONITORING DEVICE** in the name of 1.Dr. Shaikh Hasim Mohammed Isak 2. Dr. Prakash Tanaji Wankhedkar 3.Mr. Siddharth Dnyandeo Nimbalkar 4.Dr. Patel Yusuf Ebrahim.

डिजाइन अधिनियम, 2000 तथा डिजाइन नियम, 2001 के अध्याधीन प्रावधानों के अनुसरण में।  
In pursuance of and subject to the provisions of the Designs Act, 2000 and the Designs Rules, 2001.

INTELLECTUAL  
PROPERTY INDIA

EXAMINATION DESIGNS IN THE FIELD OF ARTS,  
CRAFTS AND CIRCULAR MOTION

निर्गमन की तारीख/Date of Issue : 22/12/2022

  
महानियंत्रक पेटेंट-डिजाइन और व्यापार चिह्न  
Controller General of Patents, Designs and Trade Marks

पारस्परिकता तारीख (यदि कोई हो) जिसकी अनुमति देश के नाम पर की गई है। डिजाइन का सत्त्वाधिकार पंजीकरण की तारीख से दस वर्षों के लिए होगा जिसका विस्तार, अधिनियम एवं नियम के निबंधनों के अधीन, पाँच वर्षों की अतिरिक्त अवधि के लिए किया जा सकेगा। इस प्रमाण पत्र का उपयोग विधिक कार्यवाहियों अथवा विदेश में पंजीकरण प्राप्त करने के लिए नहीं हो सकता है।

The reciprocity date (if any) which has been allowed and the name of the country. Copyright in the design will subsist for ten years from the date of Registration, and may under the terms of the Act and Rules, be extended for a further period of five years. This Certificate is not for use in legal proceedings or for obtaining registration abroad.

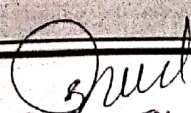
  
I.Q.A.C. Coordinator  
M.J.M. Arts, Commerce  
and Science College  
Karanjali, Nashik-422 208

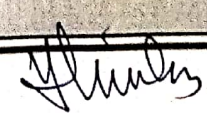
  
Principal  
M.J.M. Arts, Commerce &  
Science College Karajali,  
Tal.Peth, Dist.Nashik

पेटेंट कार्यालय  
शासकीय जर्नल

**OFFICIAL JOURNAL  
OF  
THE PATENT OFFICE**

निर्गमन सं. 16/2023  
ISSUE NO. 16/2023

शुक्रवार  
FRIDAY

दिनांक: 21/04/2023  
DATE: 21/04/2023

पेटेंट कार्यालय का एक प्रकाशन  
PUBLICATION OF THE PATENT OFFICE

The Patent Office Journal No. 16/2023 Dated 21/04/2023

32371

Design Number	366834-001	
Class	14-06	
SAMSUNG ELECTRONICS CO., LTD. 129, Samsung-ro, Yeongtong-gu, Suwon-si, Gyeonggi-do 16677, Republic of Korea		
Date of Registration	27/06/2022	
Title	STAND FOR TELEVISION	
Priority		
Priority Number	Date	Country
30-2022-0000219	04/01/2022	Republic of Korea

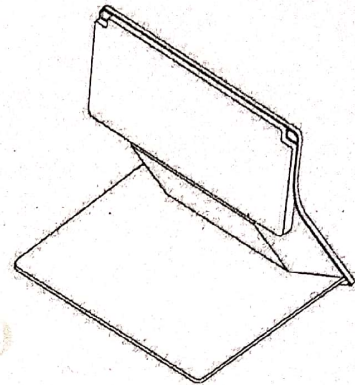

Design Number	368440-001	
Class	09-09	
1. Dr. Bhaskar Chandu More Professor and Head of Department of Zoology. Karm A.M. Patil Arts, Com. and Kai. Annasaheb N.K. Patil 2. Dr. Prakash Tanaji Wankhedkar Assistant Professor, Department of Zoology, M.J.M. ACS College, Karanjali, Tal. Peth, Dist. Nashik- 422208 3. Mr. Hitesh Bhaskar More Research Student University of Massachusetts, Lowell, United States. 01854 4. Dr. Shaikh Hasim Mohammed Isak Assistant Professor, Head of Department of Zoology, Smt.N.N. C. College Kusumba., (Dhule)		
Date of Registration	28/07/2022	
Title	VERMICOMPOST DEVICE FOR DOMESTIC USE	
Priority NA		

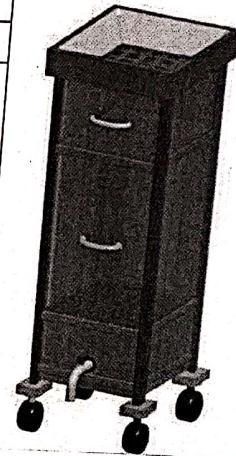

Design Number	361946-001	
Class	07-02	
Philips Domestic Appliances Holding B.V. Eindhoven, whose post-office address is, High Tech Campus 42, 5656AE Eindhoven, The Netherlands.		
Date of Registration	05/04/2022	
Title	RICE COOKER	
Priority		
Priority Number	Date	Country
008735898-0002	25/10/2021	EUIPO

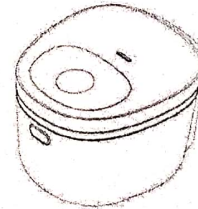



ORIGINAL

मूल/No : 133436



भारत सरकार  
GOVERNMENT OF INDIA  
पेटेंट कार्यालय  
THE PATENT OFFICE

डिजाइन के पंजीकरण का प्रमाणपत्र  
CERTIFICATE OF REGISTRATION OF DESIGN

डिजाइन सं. / Design No. : 368440-001  
तारीख / Date : 28/07/2022  
पारस्परिकता तारीख / Reciprocity Date\* :  
देश / Country :

प्रमाणित किया जाता है कि संलग्न प्रति में वर्णित डिजाइन जो **VERMICOMPOST DEVICE FOR DOMESTIC USE** से संबंधित है, का पंजीकरण, श्रेणी 09-09 में 1.Dr. Bhaskar Chandu More 2. Dr. Prakash Tanaji Wankhedhar 3.Mr. Hitesh Bhaskar More 4.Dr. Shaikh Hasim Mohammed Isak के नाम में उपर्युक्त संख्या और तारीख में कर लिया गया है।

Certified that the design of which a copy is annexed hereto has been registered as of the number and date given above in class 09-09 in respect of the application of such design to **VERMICOMPOST DEVICE FOR DOMESTIC USE** in the name of 1.Dr. Bhaskar Chandu More 2. Dr. Prakash Tanaji Wankhedhar-3.Mr. Hitesh Bhaskar More 4.Dr. Shaikh Hasim Mohammed Isak.

डिजाइन अधिनियम, 2000 तथा डिजाइन नियम, 2001 के अध्याधीन प्रावधानों के अनुसरण में।

In pursuance of and subject to the provisions of the Designs Act, 2000 and the Designs Rules, 2001.

INTELLECTUAL  
PROPERTY INDIA  
PATENTS / DESIGNS / TRADE MARKS  
GEOGRAPHICAL INDICATIONS

निर्गमन की तारीख/Date of Issue : 20/04/2023

  
महानियंत्रक पेटेंट डिजाइन और व्यापार चिह्न  
Controller General of Patents, Designs and Trade Marks

पारस्परिकता तारीख (यदि कोई हो) जिसकी अनुमति देश के नाम पर की गई है। डिजाइन का सत्त्वाधिकार पंजीकरण की तारीख से दस वर्षों के लिए होगा जिसका विस्तार, अधिनियम एवं नियम के निर्बंधनों के अर्थान, पाँच वर्षों की अतिरिक्त अवधि के लिए किया जा सकेगा। इस प्रमाण पत्र का उपयोग विधिक कार्यवाहियों अथवा विदेश में पंजीकरण प्राप्त करने के लिए नहीं हो सकता है।

\*The reciprocity date (if any) which has been allowed and the name of the country. Copyright in the design will subsist for ten years from the date of Registration, and may under the terms of the Act and Rules, be extended for a further period of five years. This Certificate is not for use in legal proceedings or for obtaining registration abroad.

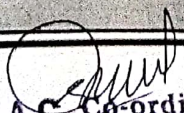
  
I.Q.A.C. Co-ordinator  
M.J.M. Arts, Commerce  
and Science College  
Karanjali, Nashik-422 208

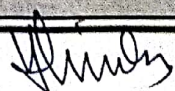
  
Principal  
M.J.M. Arts, Commerce &  
Science College Karajali,  
Tal.Peth, Dist.Nashik



पेटेंट कार्यालय  
शासकीय जर्नल

**OFFICIAL JOURNAL  
OF  
THE PATENT OFFICE**

निर्गमन सं. 13/2023  
ISSUE NO. 13/2023

शुक्रवार  
FRIDAY

दिनांक: 31/03/2023  
DATE: 31/03/2023

पेटेंट कार्यालय का एक प्रकाशन  
PUBLICATION OF THE PATENT OFFICE

The Patent Office Journal No. 13/2023 Dated 31/03/2023

28993

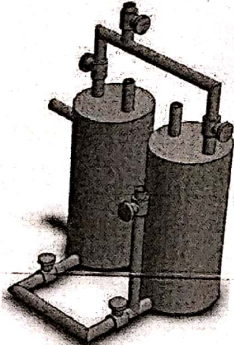
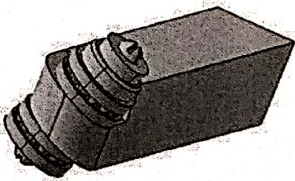
Design Number	367697-001	
Class	10-05	
<p>1. Dr. Prakash Tanaji Wankhedkar Assistant Professor, Department of Zoology, M.J.M. Art's, Commerce and Science College, Karanjali Tal Peth Dist Nashik, Maharashtra - 422208 2. Dr. Bhaskar Chandu More Professor in Zoology, Karm.A.M. Patil Arts, Commerce &amp; Kai. Annasaheb N.K. Patil Science Senior College, Pimpalner, Tal. Sakri, Dhule, Maharashtra 424306 3. Dr. Dhananjay Shivajirao Patil Assistant Professor in Zoology, Department of Zoology, NTVS's G. T. Patil college, Nandurbar 4. Dr. Shaikh Hasim Mohammed Isak Assistant Professor, Head of Department of Zoology, Smt.N.N. C. College Kusumba., (Dhule).</p>		
Date of Registration	14/07/2022	
Title	GLASS TO IDENTIFY THE QUANTITY OF SUGAR AND CALORIE IN FOOD	
Priority NA		
Design Number	314836-001	
Class	17-05	
<p>1. Vels Institute of Science Technology &amp; Advanced Studies (VISTAS) P. V. Vaithiyalingam Road, Velannagar, Pallavaram, Chennai - 600117, Tamilnadu, India 2. Chandrasekaran Manoharan Department of Automobile and Mechanical Engineering, School of Engineering, Vels Institute of Science, Technology and Advanced studies, P. V. Vaithiyalingam Road, Velannagar, Pallavaram, Chennai - 600117, TN, India 3. Shaisundaram Veerasamy Shamprasshaath Department of Automobile and Mechanical Engineering, School of Engineering, Vels Institute of Science, Technology and Advanced studies, P. V. Vaithiyalingam Road, Velannagar, Pallavaram, Chennai - 600117, TN, India 4. MuraliRaja Rajaraman Department of Automobile and Mechanical Engineering, School of Engineering, Vels Institute of Science, Technology and Advanced studies, P. V. Vaithiyalingam Road, Velannagar, Pallavaram, Chennai - 600117, TN, India , et al.</p>		
Date of Registration	13/02/2019	
Title	MOBILE ANAEROBIC DIGESTER	
Priority NA		
Design Number	377634-001	
Class	08-03	
<p>1. Mr. Nitin Shashikant Motgi Department of Mechanical Engineering, Research Scholar, Vishwakarma Institute of Information Technology, Pune and Assistant Professor, Dr. D.Y. Patil Institute of Engineering, Management and Research, Akurdi, Pune 2. Dr. Satish Suresh Chinchankar Department of Mechanical Engineering, Professor, Vishwakarma Institute of Information Technology, Pune 3. Mr. Santosh N Yalmar Partner, Aditi Tools, 26/1, F-2 Block, Near Tata Motor Material Gate, Pimpri, Pune-411018, Maharashtra, India 4. Mr. Avinash A Somatkar Department of Mechanical Engineering, Assistant Professor, Vishwakarma Institute of Information Technology, Pune , et al.</p>		
Date of Registration	18/01/2023	
Title	SELF-DRIVEN ROTARY TOOL (SDRT)	
Priority NA		



ORIGINAL

मूल/No : 132225



भारत सरकार  
GOVERNMENT OF INDIA  
पेटेंट कार्यालय  
THE PATENT OFFICE  
डिजाइन के पंजीकरण का प्रमाणपत्र  
CERTIFICATE OF REGISTRATION OF DESIGN

डिजाइन सं. / Design No. : 367697-001  
तारीख / Date : 14/07/2022  
पारस्परिकता तारीख / Reciprocity Date\* :  
देश / Country :

प्रमाणित किया जाता है कि संलग्न प्रति में वर्णित डिजाइन जो **GLASS TO IDENTIFY THE QUANTITY OF SUGAR AND CALORIE IN FOOD** से संबंधित है, का पंजीकरण, श्रेणी 10-05 में 1.Dr. Prakash Tanaji Wankhedkar 2. Dr. Bhaskar Chandu More 3.Dr. Dhananjay Shivajirao Patil 4.Dr. Shaikh Hasim Mohammed Isak के नाम में उपर्युक्त संख्या और तारीख में कर लिया गया है।

Certified that the design of which a copy is annexed hereto has been registered as of the number and date given above in class 10-05 in respect of the application of such design to **GLASS TO IDENTIFY THE QUANTITY OF SUGAR AND CALORIE IN FOOD** in the name of 1.Dr. Prakash Tanaji Wankhedkar 2. Dr. Bhaskar Chandu More 3.Dr. Dhananjay Shivajirao Patil 4.Dr. Shaikh Hasim Mohammed Isak.

डिजाइन अधिनियम, 2000 तथा डिजाइन नियम, 2001 के अध्यक्षीन प्रावधानों के अनुसरण में।  
In pursuance of and subject to the provisions of the Designs Act, 2000 and the Designs Rules, 2001.

INTELLECTUAL  
PROPERTY INDIA  
PATENTS, DESIGNS, TRADE MARKS  
GEOGRAPHICAL INDICATIONS

निर्गमन की तारीख/Date of Issue : 30/03/2023

महानियंत्रक पेटेंट डिजाइन और व्यापार चिह्न  
Controller General of Patents, Designs and Trade Marks

पारस्परिकता तारीख (यदि कोई हो) जिसकी अनुमति देश के नाम पर की गई है। डिजाइन का सत्वाधिकार पंजीकरण की तारीख से दस वर्षों के लिए होगा जिसका विस्तार, अधिनियम एवं नियम के निबंधनों के अधीन, पाँच वर्षों की अतिरिक्त अवधि के लिए किया जा सकेगा। इस प्रमाण पत्र का उपयोग विधिक कार्रवाहियों अथवा विदेश में पंजीकरण प्राप्त करने के लिए नहीं हो सकता है।  
\*The reciprocity date (if any) which has been allowed and the name of the country. Copyright in the design will subsist for ten years from the date of Registration, and may under the terms of the Act and Rules, be extended for a further period of five years. This Certificate is not for use in legal proceedings or for obtaining registration abroad.

I.Q.A.C. Co-ordinator  
M.J.M. Arts, Commerce  
and Science College  
Maranjali, Nashik-422 208

Principal  
M.J.M. Arts, Commerce &  
Science College Karajali,  
Tal.Peth, Dist.Nashik

पेटेंट कार्यालय  
शासकीय जर्नल

**OFFICIAL JOURNAL  
OF  
THE PATENT OFFICE**

निर्गमन सं. 03/2023  
ISSUE NO. 03/2023



शुक्रवार  
FRIDAY

दिनांक: 20/01/2023  
DATE: 20/01/2023

पेटेंट कार्यालय का एक प्रकाशन  
PUBLICATION OF THE PATENT OFFICE

The Patent Office Journal No. 03/2023 Dated 20/01/2023

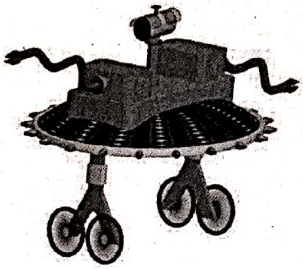
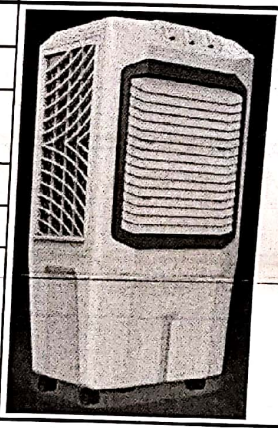
4435

Design Number	367370-001	
Class	15-03	
<b>1. Dr. Prakash Tanaji Wankhedkar Assistant Professor, Department of Zoology, M.J.M. Art's, Commerce and Science College, Karanjali Tal Peth Dist Nashik, Maharashtra - 422208</b> <b>2. Mr. Dilip Haribhau Dudhmal Assistant Professor and Head, Department of Zoology, MVP Samaj's ACS College Dindori Nashik</b> <b>3. Dr. Prashant Kantilal Bagul Research Scholar, Department of Zoology, Karm. A. M. Patil Arts, Commerce and Science College Pimpalner</b> <b>4. Dr. Dhananjay Shivajirao Patil Assistant Professor in Zoology, Department of Zoology, NTVS's G. T. Patil college, Nandurbar</b>		
Date of Registration	07/07/2022	
Title	<b>ROBOTIC DEVICE FOR PEST CONTROL IN FARM</b>	
Priority NA		
Design Number	371714-001	
Class	23-04	
<b>Godrej &amp; Boyce Manufacturing Company Ltd Pirojshanagar, Vikhroli (W), Mumbai, Maharashtra, India-400079.</b>		
Date of Registration	30/09/2022	
Title	Air Cooler	
Priority NA		
Design Number	371748-001	
Class	02-04	
<b>RELAXO FOOTWEARS LIMITED Aggarwal City Square, Plot No. 10, District Centre, Mangalam Place, Sector-03, Rohini, Delhi-110085, India</b>		
Date of Registration	30/09/2022	
Title	Footwear	
Priority NA		



ORIGINAL

मूल/No : 125596



भारत सरकार  
GOVERNMENT OF INDIA  
पेटेंट कार्यालय  
THE PATENT OFFICE

डिजाइन के पंजीकरण का प्रमाणपत्र  
CERTIFICATE OF REGISTRATION OF DESIGN

डिजाइन सं. / Design No. : 367370-001  
तारीख / Date : 07/07/2022  
पारस्परिकता तारीख / Reciprocity Date\* :  
देश / Country :

प्रमाणित किया जाता है कि संलग्न प्रति में वर्णित डिजाइन जो **ROBOTIC DEVICE FOR PEST CONTROL IN FARM** से संबंधित है, का पंजीकरण, श्रेणी 15-03 में 1.Dr. Prakash Tanaji Wankhedkar 2. Mr. Dilip Haribhau Dudhmal 3.Dr. Prashant Kantilal Bagul 4.Dr. Dhananjay Shivajirao Patil के नाम में उपर्युक्त संख्या और तारीख में कर लिया गया है।

Certified that the design of which a copy is annexed hereto has been registered as of the number and date given above in class 15-03 in respect of the application of such design to **ROBOTIC DEVICE FOR PEST CONTROL IN FARM** in the name of 1.Dr. Prakash Tanaji Wankhedkar 2. Mr. Dilip Haribhau Dudhmal 3.Dr. Prashant Kantilal Bagul 4.Dr. Dhananjay Shivajirao Patil.

डिजाइन अधिनियम, 2000 तथा डिजाइन नियम, 2001 के अध्याधीन प्रावधानों के अनुसरण में।

In pursuance of and subject to the provisions of the Designs Act, 2000 and the Designs Rules, 2001.

INTELLECTUAL  
PROPERTY INDIA  
PATENTS | DESIGNS | TRADE MARKS  
GEOGRAPHICAL INDICATIONS

निर्गमन की तारीख/Date of Issue : 16/03/2023

महानियंत्रक पेटेंट डिजाइन और व्यापार चिह्न  
Controller General of Patents, Designs and Trade Marks

पारस्परिकता तारीख (यदि कोई हो) जिसकी अनुमति देश के नाम पर की गई है। डिजाइन का सत्त्वाधिकार पंजीकरण की तारीख से दस वर्षों के लिए होगा जिसका विस्तार, अधिनियम एवं नियम के निबंधनों के अधीन, पाँच वर्षों की अतिरिक्त अवधि के लिए किया जा सकेगा। इस प्रमाण पत्र का उपयोग विधिक कार्यवाहियों अथवा विदेश में पंजीकरण प्राप्त करने के लिए नहीं हो सकता है।  
\*The reciprocity date (if any) which has been allowed and the name of the country. Copyright in the design will subsist for ten years from the date of Registration, and may under the terms of the Act and Rules, be extended for a further period of five years. This Certificate is not for use in legal proceedings or for obtaining registration abroad.

I.Q.A.C. Co-ordinator  
M.J.M. Arts, Commerce  
and Science College  
Karanjall, Nashik-422 208

Principal  
M.J.M. Arts, Commerce &  
Science College Karajali,  
Tal.Peth, Dist.Nashik

पेटेंट कार्यालय  
शासकीय जर्नल

**OFFICIAL JOURNAL  
OF  
THE PATENT OFFICE**

निर्गमन सं. 41/2022  
ISSUE NO. 41/2022

शुक्रवार  
FRIDAY

दिनांक: 14/10/2022  
DATE: 14/10/2022

पेटेंट कार्यालय का एक प्रकाशन  
PUBLICATION OF THE PATENT OFFICE

The Patent Office Journal No. 41/2022 Dated 14/10/2022

65167

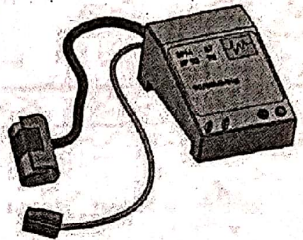
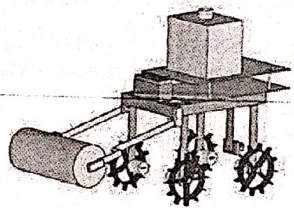
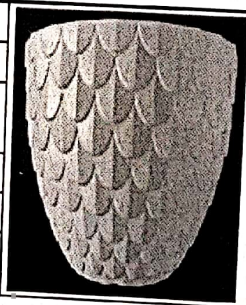
Design Number	363890-001	
Class	24-01	
<b>1. Dr. Prakash Tanaji Wankhedkar Assistant Professor, M.J.M. Art's, Commerce and Science College, Karanjali Tal Peth Dist Nashik Maharashtra - 422208</b> <b>2. Dr. Niranjana Ramesh Giri Assistant Professor, Department of Zoology, M.J.M. Art's, Commerce and Science College Karanjali Tal Peth Dist Nashik, MAHARASHTRA - 422208</b> <b>3. Dr.S.Chidambaranathan Vice Principal, Associate Professor of Computer Applications, St. Xavier's College Autonomous Palayamkottai 627002</b> <b>4. Dr Harishchander Anandaram Assistant Professor, Centre for Excellence in Computational Engineering and Networking Amrita Vishwa Vidyapeetham, Coimbatore Tamil Nadu</b>		
Date of Registration	07/05/2022	
Title	<b>IOT ENABLED DEVICE FOR MONITORING OXYGEN AND BLOOD PRSSURE IN HUMAN BODY</b>	
Priority NA		
Design Number	343749-001	
Class	15-03	
<b>1. S. RAMESH KUMAR Dept., of Mechanical Engineering, Koneru Lakshmaiah Education Foundation, Vaddeswaram, Guntur Dist., Andhra Pradesh, 522502</b> <b>2. Dr. SRIKANTH VEMURU Professor, Dept., of Computer Science and Engineering, Koneru Lakshmaiah Education Foundation, Vaddeswaram, Guntur Dist., Andhra Pradesh, 522502</b> <b>3. Dr. A. SRINATH Professor, Dept., of Mechanical Engineering, Koneru Lakshmaiah Education Foundation, Vaddeswaram, Guntur Dist., Andhra Pradesh, 522502</b>		
Date of Registration	24/05/2021	
Title	SEED SOWING ROBOT	
Priority NA		
Design Number	346222-001	
Class	11-02	
<b>NIRMIT GOEL M/s Goyal Trading Company, C-2/31, Sector 11, Rohini, New Delhi 110085 India</b>		
Date of Registration	13/07/2021	
Title	Flower Pot	
Priority NA		





ORIGINAL

No. 116892

भारत सरकार  
GOVERNMENT OF INDIA  
पेटेंट कार्यालय  
THE PATENT OFFICE

CERTIFICATE OF REGISTRATION OF DESIGN

Design No. 363890-001  
Date 07/05/2022 20:03:21  
Reciprocity Date\* 00:00:00  
Country

Certified that the design of which a copy is annexed hereto has been registered as of the number and date given above in class 24-01 in respect of the application of such design to IOT ENABLED DEVICE FOR MONITORING OXYGEN AND BLOOD PRESSURE IN HUMAN BODY in the name of 1. DR. PRAKASH TANAJI WANKHEDKAR, ASSISTANT PROFESSOR, M.J.M. ART'S, COMMERCE AND SCIENCE COLLEGE, KARANJALI TAL PETH DIST NASHIK MAHARASHTRA - 422208 2. DR. NIRANJAN RAMESH GIRI, ASSISTANT PROFESSOR, DEPARTMENT OF ZOOLOGY, M.J.M. ART'S, COMMERCE AND SCIENCE COLLEGE KARANJALI TAL PETH DIST NASHIK, MAHARASHTRA - 422208 3. DR.S.CHIDAMBARANATHAN, VICE PRINCIPAL, ASSOCIATE PROFESSOR OF COMPUTER APPLICATIONS, ST. NAVIER'S COLLEGE AUTONOMOUS PALAYANKOTTAI 627002 4. DR HARISHCHANDER ANANDARAM, ASSISTANT PROFESSOR, CENTRE FOR EXCELLENCE IN COMPUTATIONAL ENGINEERING AND NETWORKING AMRITA VISHWA VIDYAPEETHAM, COIMBATORE TAMIL NADU

in pursuance of and subject to the provisions of the Designs Act, 2000 and the Designs Rules, 2001.

Controller General of Patents, Designs and Trade Marks

\*The reciprocity date (if any) which has been allowed and the name of the country. Copyright in the design will subsist for ten years from the date of Registration, and may under the terms of the Act and Rules, be extended for a further period of five years. This Certificate is not for use in legal proceedings or for obtaining registration abroad

SAURABH KUMAR JAIN,  
SENANIP, F-440, DELTA-1, GREATER NOIDA, UP  
201310 INDIA

Date of Issue 19/09/2022 15:38:47  
NI

I.Q.A.C. Co-ordinator  
M.J.M. Arts, Commerce  
and Science College  
Karanjali, Nashik-422 208

Principal  
M.J.M. Arts, Commerce &  
Science College Karanjali,  
Tal.Peth, Dist.Nashik

पेटेंट कार्यालय  
शासकीय जर्नल

**OFFICIAL JOURNAL  
OF  
THE PATENT OFFICE**

निर्गमन सं. 19/2022  
ISSUE NO. 19/2022

शुक्रवार  
FRIDAY

दिनांक: 13/05/2022  
DATE: 13/05/2022

पेटेंट कार्यालय का एक प्रकाशन  
PUBLICATION OF THE PATENT OFFICE

The Patent Office Journal No. 19/2022 Dated 13/05/2022

29423

Principal  
Patent Office  
New Delhi

(12) PATENT APPLICATION PUBLICATION

(21) Application No.202241024831 A

(19) INDIA

(22) Date of filing of Application :27/04/2022

(43) Publication Date : 13/05/2022

(54) Title of the invention : **AI BASED EARLY-STAGE DETECTION AND PREVENTION OF MENTAL DETERIORATION AND INCURABLE BRAIN DISEASE USING IMAGE PROCESSING IN HEALTHCARE MANAGEMENT**

(51) International classification :G06K0009620000, G16H0050200000, G16H0050300000, A61B0005160000, A61B0005000000  
(86) International Application No :PCT// Filing Date :01/01/1900  
(87) International Publication No : NA  
(61) Patent of Addition to Application Number :NA Filing Date :NA  
(62) Divisional to Application Number :NA Filing Date :NA

(71)Name of Applicant :

1)Konda Hari Krishna

Address of Applicant :Assistant Professor Computer Science & Engineering Sri Vasavi Engineering College (A), Pedatadepalli, Tadepalligudem, W.G. District, A.P-534101

2)Dr. Prakash Tanaji Wankhedkar

3)Mr. Jonnala Subba Reddy

4)Dr Richa

5)Dr Harishchander Anandaram

6)Dr. S. Nalini

7)Dr.Pramod Sharma

8)Dr. Avijit Bhowmick

Name of Applicant : NA

Address of Applicant : NA

(72)Name of Inventor :

1)Konda Hari Krishna

Address of Applicant :Assistant Professor Computer Science & Engineering Sri Vasavi Engineering College (A), Pedatadepalli, Tadepalligudem, W.G. District, A.P-534101

2)Dr. Prakash Tanaji Wankhedkar

Address of Applicant :Assistant Professor M.J.M. ACS College Karanjali Tal Peth Dist Nashik Maharashtra

3)Mr. Jonnala Subba Reddy

Address of Applicant :Associate Professor, Lakireddy Bali Reddy College of Engineering, Mylavaram – 521230, AP

4)Dr Richa

Address of Applicant :Principal, Government Leather Institute , Uttar Pradesh

5)Dr Harishchander Anandaram

Address of Applicant :Assistant Professor Centre for Excellence in Computational Engineering and Networking Amrita Vishwa Vidyapeetham Coimbatore Tamil Nadu India

6)Dr. S. Nalini

Address of Applicant :Assistant professor, Department of Applied Mathematics and Computational Sciences, PSG College of Technology, Coimbatore

7)Dr.Pramod Sharma

Address of Applicant :Associate Professor, Dept. of Electronics & Comm. Engineering Raja Baiwant Singh Engineering Technical Campus Bichpuri, Agra – 283105

8)Dr. Avijit Bhowmick

Address of Applicant :Budge Budge Institute of Technology Budge Budge West Bengal Pin - 700137.

(57) Abstract :

AI based early-stage detection and prevention of mental deterioration and incurable brain disease using image processing in healthcare Management  
Abstract: It is in the country's interest that the elderly are cared for in a safe and healthy manner. According to a recent estimate, the senior population would nearly quadruple in size by 2030 as a result of new technology. Elderly persons with noninfectious cognitive impairment are at the greatest risk of developing dementia, which is caused by a decline in their bodies' ability to function as they age. Alzheimer's disease, vascular dementia, and dementia are the most prevalent disorders among those with cognitive impairments. Due to these difficulties, physical assistance is difficult to find in today's world. The greatest tactics for avoiding or learning about the disorders described above are prevention and early detection. Diabetes and hypertension are both associated with an increased incidence of Alzheimer's disease. As part of our goal to improve forecast accuracy, we offer a two-step categorization system. The purpose of this study is to determine the effect of diabetes and hypertension on cognitive decline utilising a support vector machine and the Random Forest approach (RF). Following that, a neuropsychological test called the Cognitive Ability Test is used to establish whether or not the individual is suffering from dementia. This examination is performed to assess whether or not the subject is suffering from dementia (CAT). Multinomial Logistic Regression analysis of CAT data predicts cognitive decline in the succeeding years of research participants. We classified the risk factor into three categories based on three operational criteria: No Alzheimer's, Uncertain Alzheimer's, and Definite Alzheimer's. The three operational definitions are as follows: Two distinct notes are present. The Stage 1 classifier, according to SVM and Random Forest, has an accuracy of 0.86, whereas Random Forest has an accuracy of 0.71. The accuracy is 0.89 when a multinomial Logistic classifier is used. Individuals at risk of Alzheimer's disease can be identified early on by analysing their medical records.

No. of Pages : 14 No. of Claims : 7

The Patent Office Journal No. 19/2022 Dated 13/05/2022

29813

  
I.Q.A.C. Co-ordinator  
M.J.M. Arts, Commerce  
and Science College  
Karanjall, Nashik-422 208

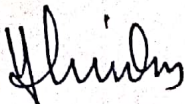
  
Principal  
M.J.M. Arts, Commerce &  
Science College Karajali,  
Tal.Peth, Dist.Nashik

पेटेंट कार्यालय  
शासकीय जर्नल

**OFFICIAL JOURNAL  
OF  
THE PATENT OFFICE**

निर्गमन सं. 52/2022  
ISSUE NO. 52/2022



शुक्रवार  
FRIDAY

दिनांक: 30/12/2022  
DATE: 30/12/2022

पेटेंट कार्यालय का एक प्रकाशन  
PUBLICATION OF THE PATENT OFFICE

The Patent Office Journal No. 52/2022 Dated 30/12/2022

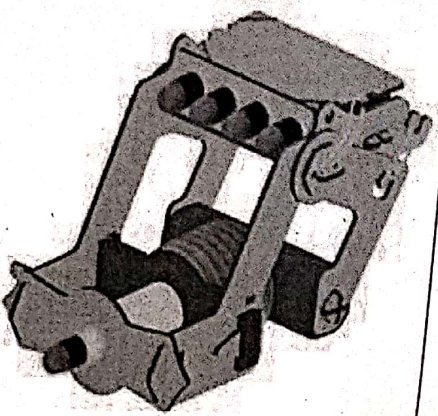
81504

Design Number	358618-001	
Class	21-01	
Smartivity Labs Private Limited 1st Floor, 258, Kuldeep House, Lane No. 3, Westend Marg, Saidulajab, New Delhi- 110030		
Date of Registration	15/02/2022	
Title	Air Blaster Toy	
Priority NA		
Design Number	362144-001	
Class	10-05	
1. Dr Sumanth Kumar Matha Faculty, Department of Environmental Sciences, Andhra University, Visakhapatnam - 530017 2. Dr. Sheerin Masroor Assistant Professor, Department of Chemistry, A.N. College, Patliputra University, Patna, 800013, Bihar, India. 3. Dr.S.Balaji Assistant Professor, Department of Zoology, Ayya Nadar Janaki Ammal College (Autonomous), Sivakasi - 626 124, Virudhunagar District, Tamil Nadu. 4. Dr Korla Swapnavahini Assistant Professor, Department of Biotechnology, Dr B.R. Ambedkar University, Srikakulam, Etcherla - 532410 , et al.		
Date of Registration	07/04/2022	
Title	DEVICE TO IDENTIFY CONTENT IN THE MIXTURE	
Priority NA		
Design Number	362145-001	
Class	10-05	
1. Dr Rupali Ahluwalia Head, Department of Commerce, St. Aloysius College, 1, Ahilya Bai Marg, Pentinaka Chowk, Sadar Cantt., Jabalpur, Madhya Pradesh, India 482001 2. Dr D. Ravindran Assistant Professor, School of Management Kristu Jayanti College (Autonomous), K.Narayanapura, Kothanur, Bengaluru, Karnataka, India 560077 3. Dr Sonal Rai Dean, Faculty of Commerce, St. Aloysius College, 1, Ahilya Bai Marg, Pentinaka Chowk, Sadar Cantt., Jabalpur, Madhya Pradesh, India 482001 4. Dr Tarvinder Kaur Co-coordinator B.Com (Hons), Assistant Professor, St. Aloysius College, 1, Ahilya Bai Marg, Pentinaka Chowk, Sadar Cantt., Jabalpur, Madhya Pradesh, India 482001		
Date of Registration	07/04/2022	
Title	CUSTOMER REQUIREMENT DETECTING DEVICE FOR SHOPPING MALL	
Priority NA		



ORIGINAL

मूल/No : 122642



भारत सरकार  
GOVERNMENT OF INDIA  
पेटेंट कार्यालय  
THE PATENT OFFICE  
डिजाइन के पंजीकरण का प्रमाणपत्र  
CERTIFICATE OF REGISTRATION OF DESIGN

डिजाइन सं. / Design No. : 362144-001  
तारीख / Date : 07/04/2022  
पारस्परिकता तारीख / Reciprocity Date\* :  
देश / Country :

प्रमाणित किया जाता है कि संलग्न प्रति में वर्णित डिजाइन जो **DEVICE TO IDENTIFY CONTENT IN THE MIXTURE** से संबंधित है, का पंजीकरण, श्रेणी 10-05 में 1.Dr Sumanth Kumar Matha 2. Dr. Sheerin Masroor 3.Dr.S.Balaji 4.Dr Korla Swapnavahini 5.Prof Dr.Jayesh Rasiklal Gujarathi 6.Dr Arti Gupta 7.Dr. G. Prakash Yoganandam 8.Mr. Anand Raj Dhanapal 9.Dr. Prakash Tanaji Wankhedkar 10.M.Sakthi Ganapathi 11.Dr Anand Shanker Singh 12.Dr. C. Ananda Vayaravel, और-अन्या-के-नाम-में उपर्युक्त संख्या और-तारीख में कर लिया गया है।

Certified that the design of which a copy is annexed hereto has been registered as of the number and date given above in class 10-05 in respect of the application of such design to **DEVICE TO IDENTIFY CONTENT IN THE MIXTURE** in the name of 1.Dr Sumanth Kumar Matha 2. Dr. Sheerin Masroor 3.Dr.S.Balaji 4.Dr Korla Swapnavahini 5.Prof Dr.Jayesh Rasiklal Gujarathi 6.Dr Arti Gupta 7.Dr. G. Prakash Yoganandam 8.Mr. Anand Raj Dhanapal 9.Dr. Prakash Tanaji Wankhedkar 10.M.Sakthi Ganapathi 11.Dr Anand Shanker Singh 12.Dr. C. Ananda Vayaravel, et al.

डिजाइन अधिनियम, 2000 तथा डिजाइन नियम, 2001 के अधधीन प्रवधानों के अनुसरण में।

In pursuance of and subject to the provisions of the Designs Act, 2000 and the Designs Rules, 2001.

INTELLECTUAL  
PROPERTY INDIA

PATENTS, DESIGNS, TRADE MARKS,  
GEOGRAPHICAL INDICATIONS

निर्गमन की तारीख/Date of Issue : 29/12/2022

महानियंत्रक पेटेंट डिजाइन और व्यापार चिह्न  
Controller General of Patents, Designs and Trade Marks

पारस्परिकता तारीख (यदि कोई हो) जिसकी अनुमति देश के नाम पर की गई है। डिजाइन का सत्वाधिकार पंजीकरण की तारीख से दस वर्षों के लिए होगा जिसका विस्तार, अधिनियम एवं नियम के निर्बंधनों के अर्थान, पाँच वर्षों की अतिरिक्त अवधि के लिए किया जा सकेगा। इस प्रमाण पत्र का उपयोग विधिक कार्यवाहियों अथवा विदेश में पंजीकरण प्राप्त करने के लिए नहीं हो सकता है।

\*The reciprocity date (if any) which has been allowed and the name of the country. Copyright in the design will subsist for ten years from the date of Registration, and may under the terms of the Act and Rules, be extended for a further period of five years. This Certificate is not for use in legal proceedings or for obtaining registration abroad.

I.Q.A.C. Co-ordinator  
M.J.M. Arts, Commerce  
and Science College  
Karanjall, Nashik-422 208

Principal  
M.J.M. Arts, Commerce &  
Science College Karajali,  
Tal Peth, Dist. Nashik

पेटेंट कार्यालय  
शासकीय जर्नल

**OFFICIAL JOURNAL  
OF  
THE PATENT OFFICE**

निर्गमन सं. 17/2022  
ISSUE NO. 17/2022

शुक्रवार  
FRIDAY

दिनांक: 29/04/2022  
DATE: 29/04/2022

पेटेंट कार्यालय का एक प्रकाशन  
PUBLICATION OF THE PATENT OFFICE

The Patent Office Journal No. 17/2022 Dated 29/04/2022

26392

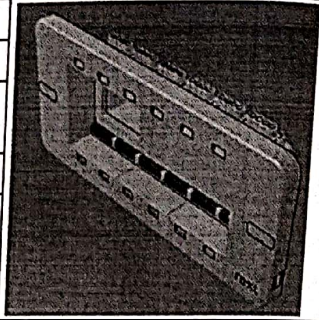
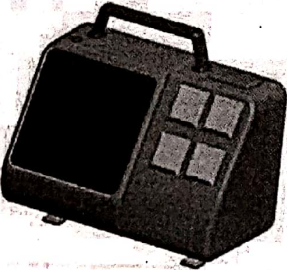
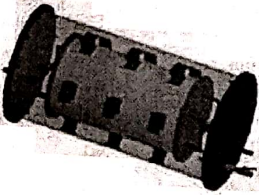
DESIGN NUMBER	357696-001	
CLASS	13-03	
NEXT PRIVATE LIMITED B 604, NANDANVAN-3, NEAR NANDINI-1, VESU, SURAT, GUJARAT - 395007.		
DATE OF REGISTRATION	01/02/2022	
TITLE	ELECTRICAL SWITCHBOARD	
PRIORITY NA		
DESIGN NUMBER	357713-001	
CLASS	10-05	
1. DR. VIKRAM RAGHUNATH KAKULTE HEAD, DEPARTMENT OF ZOOLOGY, MARATHA VIDYA PRASARAK SAMAJ'S K.R.T. ARTS, B.H. COMMERCE AND A.M. SCIENCE (KTHM) COLLEGE, GANGAPUR ROAD, NASHIK-2, 422002. INDIA 2. DR. PRAKASH TANAJI WANKHEDKAR ASSISTANT PROFESSOR, DEPARTMENT OF ZOOLOGY, SAHYADRI SHIKSHAN MANDAL'S M.J.M. ARTS, COMMERCE AND SCIENCE COLLEGE KARANJALI, TAL. PETH, DIST NASHIK-422208, INDIA 3. SHRI. SANJAY TRAMBAK PEKHALE ASSOCIATE PROFESSOR, MARATHA VIDYA PRASARAK SAMAJ'S G.M.D. ARTS, B. W. COMMERCE & SCIENCE COLLEGE, SINNAR TAL-SINNAR, DIST. NASHIK 422103. INDIA		
DATE OF REGISTRATION	02/02/2022	
TITLE	HONEY ADULTERATION TESTING DEVICE	
PRIORITY NA		
DESIGN NUMBER	357745-001	
CLASS	23-03	
1. PANDIT DEENDAYAL ENERGY UNIVERSITY RAISAN VILLAGE, GANDHINAGAR - 382007, GUJARAT, INDIA 2. SAGAR PANELIYA DEPARTMENT OF SOLAR ENERGY, SCHOOL OF TECHNOLOGY, PANDIT DEENDAYAL ENERGY UNIVERSITY, GANDHINAGAR, 382426, GUJARAT, INDIA 3. DR. SAKSHUM KHANNA DEPARTMENT OF SOLAR ENERGY, SCHOOL OF TECHNOLOGY, PANDIT DEENDAYAL ENERGY UNIVERSITY, GANDHINAGAR, 382426, GUJARAT, INDIA 4. DR. PARTH PRAJAPATI ASSISTANT PROFESSOR, DEPARTMENT OF MECHANICAL ENGINEERING, SCHOOL OF TECHNOLOGY, PANDIT DEENDAYAL ENERGY UNIVERSITY, GANDHINAGAR, 382426, GUJARAT, INDIA		
DATE OF REGISTRATION	02/02/2022	
TITLE	VACUUM BASED THERMAL ENERGY COLLECTING AND STORING TANK	
PRIORITY NA		





ORIGINAL

No. 112168

भारत सरकार  
GOVERNMENT OF INDIA  
पेटेंट कार्यालय  
THE PATENT OFFICE

CERTIFICATE OF REGISTRATION OF DESIGN

Design No. 357713-001  
Date 02/02/2022 09:02:34  
Reciprocity Date\*  
Country

Certified that the design of which a copy is annexed hereto has been registered as of the number and date given above in class 10-05 in respect of the application of such design to **HONEY ADULTERATION TESTING DEVICE** in the name of **I.DR. VIKRAM RAGHUNATH KAKULTE, HEAD, DEPARTMENT OF ZOOLOGY, MARATHA VIDYA PRASARAK SAMAJ'S K.R.T. ARTS, B.H. COMMERCE AND A.M. SCIENCE (KTHM) COLLEGE, GANGAPUR ROAD, NASHIK-2, 422002, INDIA 2. DR. PRAKASH TANAJI WANKHEDKAR, ASSISTANT PROFESSOR, DEPARTMENT OF ZOOLOGY, SAHYADRI SHIKSHAN MANDAL'S M.J.M. ARTS, COMMERCE AND SCIENCE COLLEGE KARANJALI, TAL. PETH, DIST NASHIK-422208, INDIA 3. SHRI. SANJAY TRAMBAK PEKHALE, ASSOCIATE PROFESSOR, MARATHA VIDYA PRASARAK SAMAJ'S G.M.D. ARTS, B. W. COMMERCE & SCIENCE COLLEGE, SINNAR TAL-SINNAR, DIST. NASHIK 422103, INDIA**

in pursuance of and subject to the provisions of the Designs Act, 2000 and the Designs Rules, 2001.

Controller General of Patents, Designs and Trade Marks

\*The reciprocity date (if any) which has been allowed and the name of the country.  
Copyright in the design will subsist for ten years from the date of Registration, and may under the terms of the Act and Rules, be extended for a further period of five years.  
This Certificate is not for use in legal proceedings or for obtaining registration abroad

DR. VIKRAM RAGHUNATH KAKULTE,  
MARATHA VIDYA PRASARAK SAMAJ'S K.R.T. ARTS,  
B.H. COMMERCE AND A.M. SCIENCE (KTHM)  
COLLEGE, GANGAPUR ROAD, NASHIK-2, 422002, MH

Date of Issue 25/04/2022 15:47:40

I.Q.A.C. Co-ordinator  
M.J.M. Arts, Commerce  
and Science College  
Karanjali, Nashik-422 208

Principal  
M.J.M. Arts, Commerce &  
Science College Karajali,  
Tal:Peth, Dist.Nashik

पेटेंट कार्यालय  
शासकीय जर्नल

**OFFICIAL JOURNAL  
OF  
THE PATENT OFFICE**

निर्गमन सं. 02/2023  
ISSUE NO. 02/2023

शुक्रवार  
FRIDAY

दिनांक: 13/01/2023  
DATE: 13/01/2023

पेटेंट कार्यालय का एक प्रकाशन  
PUBLICATION OF THE PATENT OFFICE

The Patent Office Journal No. 02/2023 Dated 13/01/2023

2646

Design Number	373516-001	
Class	02-03	
<p>1. Mr. S. Alaguraja Assistant Professor, Department of Physics, Thiagarajar College, 139-140, Kamarajar Salai, Near Teppakulam, Madurai- 625009. 2. Dr. L. Leena Hebsi Bai Guest lecturer, Department of chemistry, Raja Doraisingam Govt. Arts College, Manamadurai Road Sivagangai - 630 561, Tamil Nadu, India 3. Mrs. V. Vanitha Assistant professor PG And Research Department Of Chemistry G.T.N Arts College, (Autonomous), Dindigul – 624005 Tamil Nadu, India 4. Dr. R. Sivaperumal Department of biotechnology, Theni college of arts and science, Veerapandi-625 534, Theni (district) , et al.</p>		
Date of Registration	03/11/2022	
Title	SOLAR STEEL HELMET	
Priority NA		
Design Number	373524-001	
Class	12-16	
<p>IGOR AKRAPOVIC Rožna dolina, cesta VIII/10A SI-1000, Ljubljana, Slovenia</p>		
Date of Registration	03/11/2022	
Title	SPOILER FOR MOTOR CAR	
Priority		
Priority Number	Date	Country
009023807-0001	12/05/2022	EUIPO
Design Number	373525-001	
Class	24-04	
<p>1. Dr. Prakash Tanaji Wankhedkar Assistant Professor, Department of Zoology, M.J.M. Arts, Commerce and Science College, Karanjali, Tal. Peth, Dist. Nashik- 422208 2. Dr. Dhananjay Shivajirao Patil Assistant Professor, Department of Zoology, NTVS's G.T. Patil College, Nandurbar, Maharashtra-425412 3. Dr. Prashant Kantilal Bagul Research Scholar, Department of Zoology, Karm. A.M. Patil Arts, Commerce and Science College, Pimpalner – 424306</p>		
Date of Registration	03/11/2022	
Title	ELECTROCARDIOGRAM DETECTING VEST	
Priority NA		

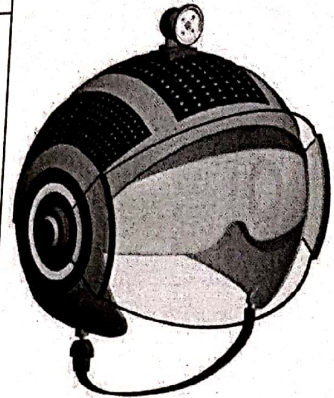



ORIGINAL

मूल/No : 125357



भारत सरकार  
GOVERNMENT OF INDIA  
पेटेंट कार्यालय  
THE PATENT OFFICE

डिजाइन के पंजीकरण का प्रमाणपत्र  
CERTIFICATE OF REGISTRATION OF DESIGN

डिजाइन सं. / Design No. : 373525-001  
तारीख / Date : 03/11/2022  
पारस्परिकता तारीख / Reciprocity Date\* :  
देश / Country :

प्रमाणित किया जाता है कि संलग्न प्रति में वर्णित डिजाइन जो **ELECTROCARDIOGRAM DETECTING VEST** से संबंधित है, का पंजीकरण, श्रेणी 24-04 में 1. Dr. Prakash Tanaji Wankhedkar 2. Dr. Dhananjay Shivajirao Patil 3. Dr. Prashant Kantilal Bagul के नाम में उपर्युक्त संख्या और तारीख में कर लिया गया है।

Certified that the design of which a copy is annexed hereto has been registered as of the number and date given above in class 24-04 in respect of the application of such design to **ELECTROCARDIOGRAM DETECTING VEST** in the name of 1. Dr. Prakash Tanaji Wankhedkar 2. Dr. Dhananjay Shivajirao Patil 3. Dr. Prashant Kantilal Bagul.

डिजाइन अधिनियम, 2000 तथा डिजाइन नियम, 2001 के अधधीन प्रावधानों के अनुसरण में।  
In pursuance of and subject to the provisions of the Designs Act, 2000 and the Designs Rules, 2001.

INTELLECTUAL  
PROPERTY INDIA

DEPARTMENTS OF PATENTS, DESIGNS, TRADE MARKS  
& GEOGRAPHICAL INDICATIONS

निर्गमन की तारीख/Date of Issue : 13/01/2023

महानियंत्रक पेटेंट डिजाइन और व्यापार चिह्न  
Controller General of Patents, Designs and Trade Marks

पारस्परिकता तारीख (यदि कोई हो) जिसकी अनुमति देश के नाम पर की गई है। डिजाइन का सत्वाधिकार पंजीकरण की तारीख से दस वर्षों के लिए होगा जिसका विस्तार, अधिनियम एवं नियम के निर्बंधनों के अर्थान, पाँच वर्षों की अतिरिक्त अवधि के लिए किया जा सकेगा। इस प्रमाण पत्र का उपयोग विधिक कार्यवाहियों अथवा विदेश में पंजीकरण प्राप्त करने के लिए नहीं हो सकता है।

\*The reciprocity date (if any) which has been allowed and the name of the country. Copyright in the design will subsist for ten years from the date of Registration, and may under the terms of the Act and Rules, be extended for a further period of five years. This Certificate is not for use in legal proceedings or for obtaining registration abroad.

I.Q.A.C. Co-ordinator  
M.J.M. Arts, Commerce  
and Science College  
Karanjali, Nashik-422 208

Principal  
M.J.M. Arts, Commerce &  
Science College Karajali,  
Tal. Peth, Dist. Nashik

पेटेंट कार्यालय  
शासकीय जर्नल

**OFFICIAL JOURNAL  
OF  
THE PATENT OFFICE**

निर्गमन सं. 41/2022  
ISSUE NO. 41/2022

शुक्रवार  
FRIDAY

दिनांक: 14/10/2022  
DATE: 14/10/2022

पेटेंट कार्यालय का एक प्रकाशन  
PUBLICATION OF THE PATENT OFFICE

The Patent Office Journal No. 41/2022 Dated 14/10/2022

65167

Design Number	363890-001
Class	24-01
<b>1. Dr. Prakash Tanaji Wankhedkar Assistant Professor, M.J.M. Art's, Commerce and Science College, Karanjali Tal Peth Dist Nashik Maharashtra - 422208</b> <b>2. Dr. Niranjana Ramesh Giri Assistant Professor, Department of Zoology, M.J.M. Art's, Commerce and Science College Karanjali Tal Peth Dist Nashik, MAHARASHTRA - 422208</b> <b>3. Dr. S. Chidambaram Vice Principal, Associate Professor of Computer Applications, St. Xavier's College Autonomous Palayamkottai 627002</b> <b>4. Dr. Harishchander Anandaram Assistant Professor, Centre for Excellence in Computational Engineering and Networking Amrita Vishwa Vidyapeetham, Coimbatore Tamil Nadu</b>	

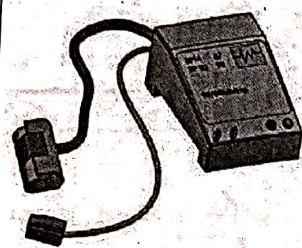

Date of Registration	07/05/2022
Title	<b>IOT ENABLED DEVICE FOR MONITORING OXYGEN AND BLOOD PRSSURE IN HUMAN BODY</b>

Priority NA	
-------------	--

Design Number	343749-001
Class	15-03
<b>1. S. RAMESH KUMAR Dept., of Mechanical Engineering, Koneru Lakshmaiah Education Foundation, Vaddeswaram, Guntur Dist., Andhra Pradesh, 522502</b> <b>2. Dr. SRIKANTH VEMURU Professor, Dept., of Computer Science and Engineering, Koneru Lakshmaiah Education Foundation, Vaddeswaram, Guntur Dist., Andhra Pradesh, 522502</b> <b>3. Dr. A. SRINATH Professor, Dept., of Mechanical Engineering, Koneru Lakshmaiah Education Foundation, Vaddeswaram, Guntur Dist., Andhra Pradesh, 522502</b>	

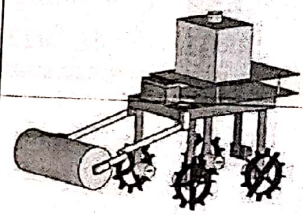

Date of Registration	24/05/2021
Title	SEED SOWING ROBOT

Priority NA	
-------------	--

Design Number	346222-001
Class	11-02

<b>NIRMIT GOEL M/s Goyal Trading Company, C-2/31, Sector 11, Rohini, New Delhi 110085 India</b>	
Date of Registration	13/07/2021
Title	Flower Pot

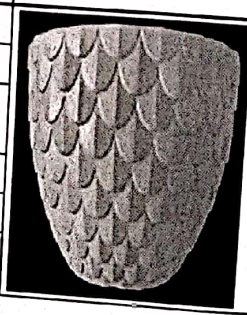

Priority NA	
-------------	--



ORIGINAL

No. 116892

भारत सरकार  
GOVERNMENT OF INDIA  
पेटेंट कार्यालय  
THE PATENT OFFICE

CERTIFICATE OF REGISTRATION OF DESIGN

Design No.	363890-001
Date	07/05/2022 20:03:21
Reciprocity Date*	00:00:00
Country	

Certified that the design of which a copy is annexed hereto has been registered as of the number and date given above in class 24-01 in respect of the application of such design to IOT ENABLED DEVICE FOR MONITORING OXYGEN AND BLOOD PRESSURE IN HUMAN BODY in the name of 1. DR. PRAKASH TANAJI WANKHEDKAR, ASSISTANT PROFESSOR, M.J.M. ART'S, COMMERCE AND SCIENCE COLLEGE, KARANJALI TAL PETH DIST NASHIK MAHARASHTRA - 422208 2. DR. NIRANJAN RAMESH GIRI, ASSISTANT PROFESSOR, DEPARTMENT OF ZOOLOGY, M.J.M. ART'S, COMMERCE AND SCIENCE COLLEGE KARANJALI TAL PETH DIST NASHIK, MAHARASHTRA - 422208 3. DR.S.CHIDAMBARANATHAN, VICE PRINCIPAL, ASSOCIATE PROFESSOR OF COMPUTER APPLICATIONS, ST. XAVIER'S COLLEGE AUTONOMOUS PALAYAMKOTTAI 627002 4. DR HARISHCHANDER ANANDARAM, ASSISTANT PROFESSOR, CENTRE FOR EXCELLENCE IN COMPUTATIONAL ENGINEERING AND NETWORKING AMRITA VISHWA VIDYAPEETHAM, COIMBATORE TAMILNADU

in pursuance of and subject to the provisions of the Designs Act, 2000 and the Designs Rules, 2001.

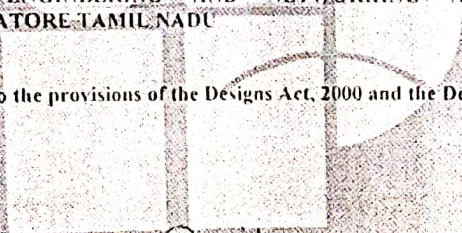

*Saurabh Kumar Jain*

Controller General of Patents, Designs and Trade Marks

\*The reciprocity date (if any) which has been allowed and the name of the country.  
Copyright in the design will subsist for ten years from the date of Registration, and may under the terms of the Act and Rules, be extended for a further period of five years.  
This Certificate is not for use in legal proceedings or for obtaining registration abroad

SAURABH KUMAR JAIN,  
SENANIP, F-440, DELTA-I, GREATER NOIDA, UP  
201310 INDIA

Date of Issue 19/09/2022 15:38:47  
NF

*Saurabh Kumar Jain*  
L.Q.A.C. Co-ordinator  
M.J.M. Arts, Commerce  
and Science College  
Karanjali, Nashik-422 208

*Saurabh Kumar Jain*  
Principal  
M.J.M. Arts, Commerce  
and Science College  
Karanjali, Dist. Nashik

पेटेंट कार्यालय  
शासकीय जर्नल

**OFFICIAL JOURNAL  
OF  
THE PATENT OFFICE**

निर्गमन सं. 38/2022  
ISSUE NO. 38/2022

शुक्रवार  
FRIDAY

दिनांक: 23/09/2022  
DATE: 23/09/2022

पेटेंट कार्यालय का एक प्रकाशन  
PUBLICATION OF THE PATENT OFFICE

The Patent Office Journal No. 38/2022 Dated 23/09/2022

60202



Design Number	362812-001	
Class	30-06	
KWANZA MEDITECH PRIVATE LIMITED SR.NO.66/1 2A, Nav Vinayak Society, Karve Road, Kothrud, Pune, 411038, Maharashtra, India		
Date of Registration	20/04/2022	
Title	VETERINARY BED	
Priority NA		
Design Number	362826-001	
Class	23-03	
1. Dr. Amol Balbhim Mamlayya Assistant Professor, Department of Zoology, Rayat Shikshan Sanstha's, Karmaveer Bhaurao Patil Mahavidyalaya, Pandharpur (Autonomous), Tal. Pandharpur, Dist. Solapur, Pin 413304 2. Dr. Suresh Tukaram Salunkhe Principal, Rayat Shikshan Sanstha's, Dahiwadi College, Dahiwadi, Tal. Man, District Satara Pin 415508 3. Dr. Varsha Sandip Kumbhar Assistant Professor, Department of Zoology Bharati Vidyapeeth's, Dr. Patangrao Kadam Mahavidyalaya, Sangli, Tal. Miraj, Dist. Sangli Pin 416 416 4. Dr. Niranjan Ramesh Giri Assistant Professor, Head Department of Zoology, Sahyadri Shikshan Mandal's, Dindori, Mahant Jamanadas Maharaj, Arts, Commerce and Science College Karanjali Tal Peth Dist Nashik 422208		
Date of Registration	20/04/2022	
Title	SOLAR-POWERED INSECT DRYING CHAMBER	
Priority NA		
Design Number	362834-001	
Class	16-02	
Samsung Electronics Co., Ltd. 129, Samsung-ro, Yeongtong-gu, Suwon-si, Gyeonggi-do, 16677, Republic of Korea		
Date of Registration	20/04/2022	
Title	CASE FOR BEAM PROJECTOR	
Priority		
Priority Number	Date	Country
30-2021-0050924	27/10/2021	Republic of Korea

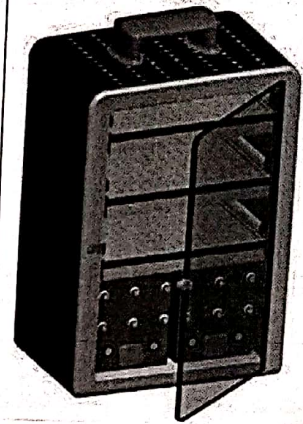
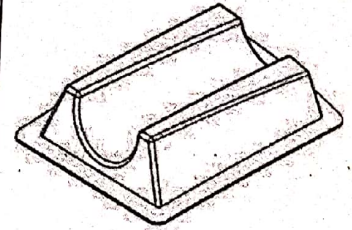



ORIGINAL

No. 117363

भारत सरकार  
GOVERNMENT OF INDIA  
पेटेंट कार्यालय  
THE PATENT OFFICE

CERTIFICATE OF REGISTRATION OF DESIGN

Design No. 362826-001  
Date 20/04/2022  
Reciprocity Date\*  
Country

Certified that the design of which a copy is annexed hereto has been registered as of the number and date given above in class 23-03 in respect of the application of such design to **SOLAR-POWERED INSECT DRYING CHAMBER** in the name of 1. DR. AMOL BALBHIM MAMLAYYA ASST. PROF., DEPT. OF ZOOLOGY, RAYAT SHIKSHAN SANSTHA'S, KARMAVEER BHAURAO PATIL MAHAVIDYALAYA, PANDHARPUR (AUTONOMOUS), TAL. PANDHARPUR, DIST. SOLAPUR, PIN 413304 2. DR. SURESH TUKARAM SALUNKHE, PRINCIPAL, RAYAT SHIKSHAN SANSTHA'S, DAHIWADI COLLEGE, DAHIWADI, TAL. MAN, DISTRICT SATARA PIN 415508 3. DR. VARSHA SANDIP KUMBHAR, ASST. PROF., DEPT. OF ZOOLOGY BHARATI VIDYAPEETH'S, DR. PATANGRAO KADAM MAHAVIDYALAYA, SANGLI, TAL. MIRAJ, DIST. SANGLI PIN 416 416 4. DR. NIRANJAN RAMESH GIRI, ASST. PROF., HEAD DEPT. OF ZOOLOGY, SAHYADRI SHIKSHAN MANDAL'S, DINDORI, MAHANT JAMANADAS MAHARAJ, ARTS, COMMERCE AND SCIENCE COLLEGE KARANJALI TAL PETH DIST NASHIK 422208

in pursuance of and subject to the provisions of the Designs Act, 2000 and the Designs Rules, 2001.

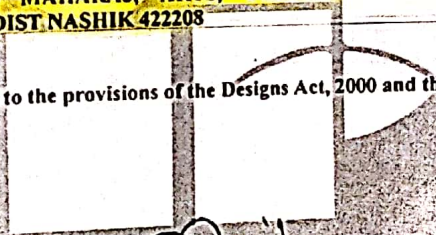

*[Handwritten Signature]*

Controller General of Patents, Designs and Trade Marks

\*The reciprocity date (if any) which has been allowed and the name of the country. Copyright in the design will subsist for ten years from the date of Registration, and may under the terms of the Act and Rules, be extended for a further period of five years. This Certificate is not for use in legal proceedings or for obtaining registration abroad

DR. AMOL BALBHIM MAMLAYYA,  
MARATHA VIDYA PRASARAK SAMAJ'S K.R.T. ARTS,  
B.H. COMMERCE AND A.M. SCIENCE (KTHM)  
COLLEGE, GANGAPUR ROAD, NASHIK-2, 422002.

Date of Issue 30/09/2022 17:21:38

*[Handwritten Signature]*  
I.Q.A.C. Co-ordinator  
M.J.M. Arts, Commerce  
and Science College  
Karanjali, Nashik-422 208

*[Handwritten Signature]*  
Principal  
M.J.M. Arts, Commerce &  
Science College Karanjali,  
Tal. Peth, Dist. Nashik

CS CamScanner



SCT72100302

**Savitribai Phule Pune University**

(Formerly University of Pune)



Telephone No: 25621171/1174

E-mail : rr@unipune.ac.in

Telegraph : 'UNIPUNE'

Fax No : 25691233

**ACADEMIC SECTION**  
Ganeshkhind, PUNE-411 007

Ref. No: BOD/Sci. &amp; Tech./22/17

Date: 08/01/2022

**To**Dr. Avinash Shivaji Jondhale  
Sahyadri Shikshan Sanstha Mahant  
Jamanadas Maharaj College Addr: At post  
Karanjali Ta: Peth Dist: Nashik Pincode  
:422208**Subject: Recognition as a Ph.D. Research Guide**

Sir,

Please refer to your application for Recognition as a Ph.D. Research Guide of Savitribai Phule Pune University. I am directed to inform you that the University authorities have been pleased to recognize you as a Ph.D. Research Guide of this University under the provision of Section 37(1) (e) of the Maharashtra Public Universities Act, 2016.

*The details of your recognition are as under:*

Designation	Faculty	Subject	Recognition on	Duration	No. of Students Allowed
Assistant Professor	Science and Technology	Botany	Ph.D. Guide	w.e.f. 05-01-2022 To 18/05/2046 (To Superannuation)	4 Ph.D.

Your guideship is subject to the following conditions and other terms and conditions prescribed by the University and University Grants Commission, (UGC) New Delhi from time to time in this behalf:

- i) Ph.D./M.Phil Research Guideship will be governed by the University Grants Commission (Minimum Standards and Procedure for Award of Ph.D./M.Phil Degree) Regulations 2016.
- ii) a) If the affiliation/Recognition granted by the university to your College/Institute gets over then the recognition granted to you will be treated as cancelled from the date on which the period of affiliation/recognition gets over.  
b) In case of Research Institute, it should be recognized by the University for the subject for which you are recognized as Ph.D./M.Phil Research Guide.
- iii) No fresh Ph.D./M.Phil 'Research Students' should be registered with Ph.D./M.Phil Research Guides whose length of service as a regular faculty is left not more than one year and in such case you have to compulsorily assign Co- guide to the Research Students working under you.

In addition to the above conditions, it is essential to mention the name of 'Savitribai Phule Pune University' in author's address in the Publications made by you and your students.

Recognition granted to you is always subject to the terms and conditions prescribed by the University and University Grants Commission, New Delhi from time to time, in this behalf.

If any correction in the recognition letter then please contact this office within fifteen days from the date of receipt of this letter.

iv) If you change the existing College/ Institute, after getting University teacher approval, you have to apply online for address change.

Yours,

(Dr. M.V. Rasve)  
Deputy Registrar  
Academic Section

Copy fwcs to :

1. The Dean, Faculty of Science and Technology,
2. The Principal, Sahyadri Shikshan Sanstha Mahant Jamanadas Maharaj, College Addr: At post Karanjali Tal. Peth Dist: Nashik.
3. The Deputy Registrar (Admission), Savitribai Phule Pune University, Pune-411 007.

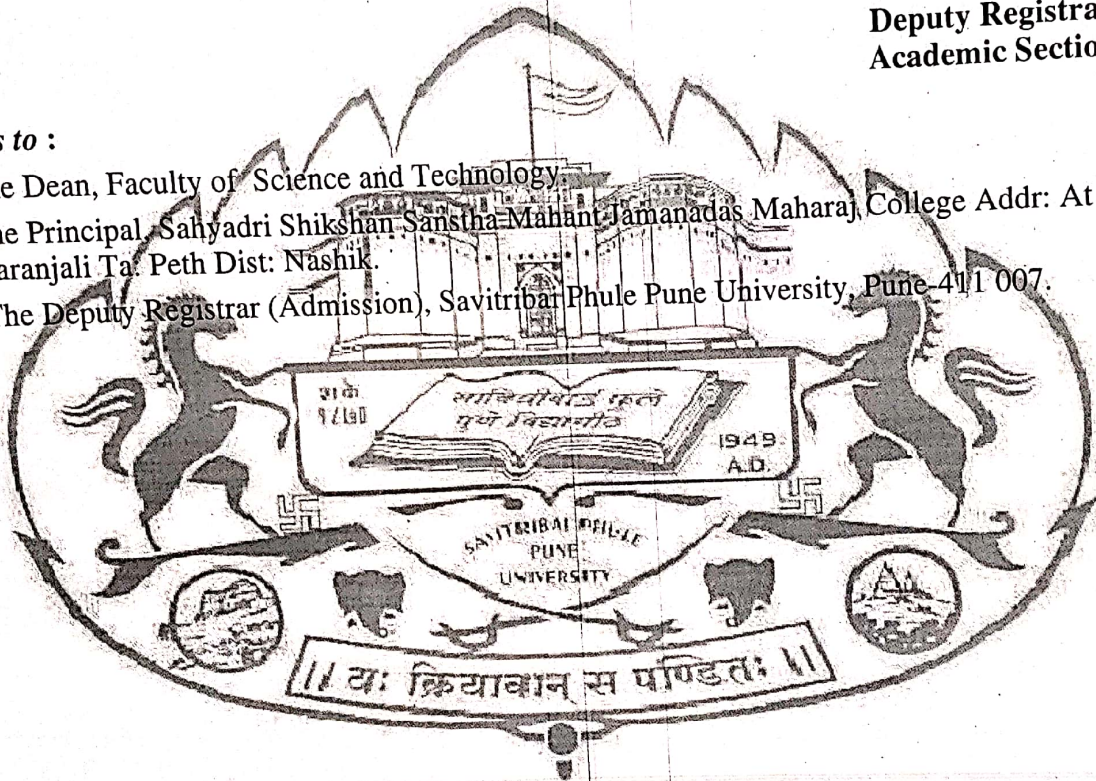

Principal  
M.J.M. Arts, Commerce &  
Science College Karajali,  
Tal.Peth, Dist.Nashik

I.Q.A.C. Co-ordinator  
M.J.M. Arts, Commerce  
and Science College  
Karanjali, Nashik-422 208



SCT82100455

# Savitribai Phule Pune University

(Formerly University of Pune)



Telephone No: 25621171/1174  
 E-mail : rr@unipune.ac.in  
 Telegraph : 'UNIPUNE'  
 Fax No : 25691233

ACADEMIC SECTION  
 Ganeshkhind, PUNE-411 007

Ref. No: BOD/Sci. &amp; Tech./24/17

Date: 08/01/2022

**To**

Dr. Smita Pandurang Chavan  
 Sahyadri Shikshan Sanstha Mahant  
 Jamanadas Maharaj College Addr: At post  
 Karanjali Ta: Peth Dist: Nashik Pincode  
 :422208

**Subject: Recognition as a Ph.D. Research Guide**

Madam,

Please refer to your application for Recognition as a Ph.D. Research Guide of Savitribai Phule Pune University, I am directed to inform you that the University authorities have been pleased to recognize you as a Ph.D. Research Guide of this University under the provision of Section 37(1) (e) of the Maharashtra Public Universities Act, 2016.

*The details of your recognition are as under:*

Designation	Faculty	Subject	Recognition on	Duration	No. of Students Allowed
Assistant Professor	Science and Technology	Botany	Ph.D. Guide	w.e.f. 05-01-2022 To 01/03/2044 (To Superannuation)	4 Ph.D.

Your guideship is subject to the following conditions and other terms and conditions prescribed by the University and University Grants Commission, (UGC) New Delhi from time to time in this behalf:

- i) Ph.D./M.Phil Research Guideship will be governed by the University Grants Commission (Minimum Standards and Procedure for Award of Ph.D./M.Phil Degree) Regulations 2016.
- ii) a) If the affiliation/Recognition granted by the university to your College/Institute gets over then the recognition granted to you will be treated as cancelled from the date on which the period of affiliation/recognition gets over.  
 b) In case of Research Institute, it should be recognized by the University for the subject for which you are recognized as Ph.D./M.Phil Research Guide.
- iii) No fresh Ph.D./M.Phil 'Research Students' should be registered with Ph.D./M.Phil Research Guides whose length of service as a regular faculty is left not more than one year and in such case you have to compulsorily assign Co- guide to the Research Students working under you.

In addition to the above conditions, it is essential to mention the name of 'Savitribai Phule Pune University' in author's address in the Publications made by you and your students.

Recognition granted to you is always subject to the terms and conditions prescribed by the University and University Grants Commission, New Delhi from time to time, in this behalf.

If any correction in the recognition letter then please contact this office within fifteen days from the date of receipt of this letter.

- iv) If you change the existing College/ Institute, after getting University teacher approval, you have to apply online for address change.

Yours,

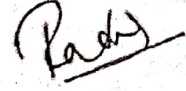



(Dr. M.V. Rasve)  
Deputy Registrar  
Academic Section

Copy fwcs to :

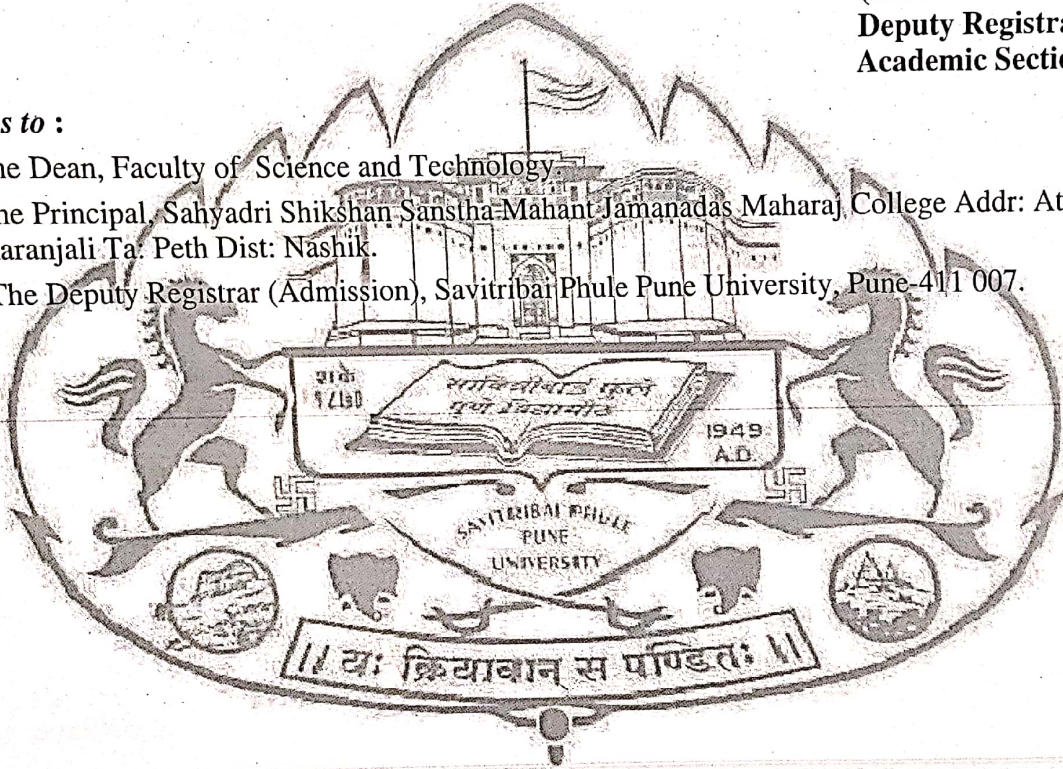
1. The Dean, Faculty of Science and Technology
2. The Principal, Sahyadri Shikshan Sansha Mahant Jamanadas Maharaj College Addr: At post Karanjali Ta: Peth Dist: Nashik.
3. The Deputy Registrar (Admission), Savitribai Phule Pune University, Pune-411 007.



  
**Principal**  
M.J.M. Arts, Commerce &  
Science College Karajali,  
Tal.Peth, Dist.Nashik

  
**I.Q.A.C. Co-ordinator**  
M.J.M. Arts, Commerce  
and Science College  
Karanjali, Nashik-422 208



**Savitribai Phule Pune University**  
(Formerly University of Pune)

Telephone No: 25621171/1174  
E-mail : rr@unipune.ac.in  
Telegraph : 'UNIPUNE'  
Fax No : 25691233



**ACADEMIC SECTION**  
Ganeshkhind, PUNE-411 007

Ref. No: BOD/Sci. & Tech./21/255

Date: 21/10/2021

To

Dr.Mahendra Shantaram Shinde  
Sahyadri Shikshan Sanstha Mahant  
Jamanadas Maharaj College Addr: At post  
Karanjali Ta: Peth Dist: Nashik Pincode  
:422208

**Subject : Recognition as a Ph.D. Research Guide**

Sir,

Please refer to your application for Recognition as a Ph.D. Research Guide of Savitribai Phule Pune University. I am directed to inform you that the University authorities have been pleased to recognize you as a Ph.D. Research Guide of this University under the provision of Section 37(1) (e) of the Maharashtra Public Universities Act, 2016.

*The details of your recognition are as under.*

1. You have been recognized to guide **Ph. D. Scholars** under the faculty of **Science and Technology** in the subject of **Physics** for with effect from **20-09-2021** to **19-09-2029** with following particulars,

i) Four (4) Ph.D. Scholars, if you are an Assistant Professor.

Your guideship is subject to the following conditions and other terms and conditions prescribed by the University and University Grants Commission, (UGC) New Delhi from time to time in this behalf:

- i) M.Phil/Ph.D. Research Guideship will be governed by the University Grants Commission, (Minimum Standards and Procedure for Award of M.Phil/Ph.D. Degree) Regulations 2016.
- ii) a) If the affiliation/Recognition granted by the university to your College/Institute gets over then the recognition granted to you will be treated as cancelled from the date on which the period of affiliation/recognition gets over.  
b) In case of Research Institute, it should be recognized by the University for the subject for which you are recognized as M.Phil/Ph.D. Research Guide.  
If the recognition granted by the University to your Research Institute gets over then your recognition as an M.Phil/Ph.D. Research Guide will be treated as cancelled from the date on which the recognition to your Research Institute gets over.
- iii) In case of those M.Phil/Ph.D. Guides whose length of service as a regular faculty is not more than two years, in such cases it is essential for them to take a Co-Guide whose length of service as a regular faculty should not be less than five years and the said Co-Guide should be approved M.Phil/Ph.D. Guide of Savitribai Phule Pune University.
- iv) No fresh M.Phil/Ph.D. 'Research Students' should be registered with M.Phil/Ph.D. Research Guides whose length of service as a regular faculty is not more than two years.

In addition to the above conditions, it is essential to mention the name of 'Savitribai Phule Pune University' in author's address in the Publications made by you and your students.

Recognition granted to you is always subject to the terms and conditions prescribed by the University and University Grants Commission, New Delhi from time to time, in this behalf.

If any correction in the recognition letter then please contact this office within fifteen days from the date of receipt of this letter.

Thanking you,

Yours,

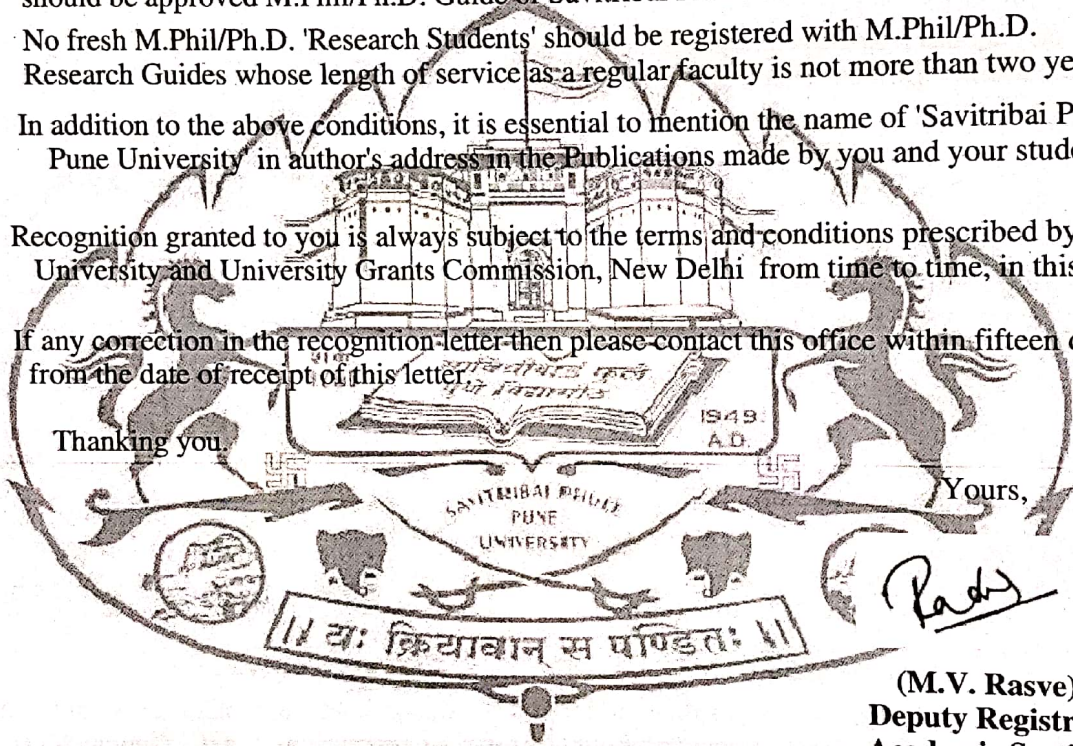

(M.V. Rasve)  
Deputy Registrar  
Academic Section

Copy fwcs to :

1. The Dean, Faculty of Science and Technology.
2. The Principal, Sahyadri Shikshan Sanstha Mahant Jamanadas Maharaj College Addr: At post Karanjali Ta: Peth Dist: Nashik.
3. The Deputy Registrar (Admission), Savitribai Phule Pune University, Pune-411 007.

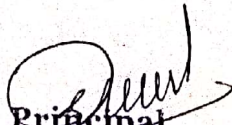
  
Principal  
M.J.M. Arts, Commerce &  
Science College Karanjali 2  
Tal.Peth, Dist.Nashik

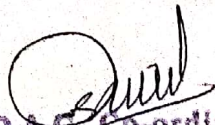
  
I.Q.A.C. co-ordinator  
M.J.M. Arts, Commerce  
and Science College  
Karanjali, Nashik-422 208





सावित्रीबाई फुले पुणे विद्यापीठ  
गणेशखिंड, पुणे - ४११ ००७.  
Savitribai Phule Pune University  
Ganeshkhind, Pune - 411007.

दूरध्वनी क्रमांक : ०२०-२५६२११५६/५७/७४  
Telephone : 020-25621156/57/74  
ईमेल / Email : rr@unipune.ac.in

Date: 30/01/2023

Ref. No: BOD/Sci. & Tech./14/10

To  
Dr. Ravindra Haribhau Waghchaure  
Sahyadri Shikshan Sanstha Mahant  
Jamanadas Maharaj College Addr: At post  
Karanjali Ta: Peth Dist: Nashik Pincode  
:422208

**Subject : Recognition as a Post Graduate Teacher, M.Phil. & Ph.D. Research Guide**

Sir,

Please refer to your application for Recognition as a Post Graduate Teacher, M.Phil. & Ph.D. Research Guide of Savitribai Phule Pune University, I am directed to inform you that the University authorities have been pleased to recognize you as a Post Graduate Teacher, M.Phil. & Ph.D. Research Guide of this University under the provision of Section 37(1)(e) of the Maharashtra Public Universities Act, 2016.

*The details of your recognition are as under :*

Designation	Faculty	Subject	Recognition on	Duration	No. of Students Allowed
Assistant Professor	Science and Technology	Chemistry	P. G. Teacher M.Phil. By Paper M.Phil. By Research Ph.D. Guide	w.e.f. 14-12-2022 w.e.f. 14-12-2022 w.e.f. 14-12-2022 w.e.f. 14-12-2022 To 06/06/2045 (To Superannuation)	4 - Ph.D., 1 - M. Phil.

Your guideship is subject to the following conditions and other terms and conditions prescribed by the University and University Grants Commission, (UGC) New Delhi from time to time in this behalf:

- Ph.D./M.Phil Research Guideship will be governed by the University Grants Commission (Minimum Standards and Procedure for Award of Ph.D./M.Phil Degree) Regulations 2016.
- If the affiliation/Recognition granted by the university to your College/Institute gets over then the recognition granted to you will be treated as cancelled from the date on which the period of affiliation/recognition gets over.
  - In case of Research Institute, it should be recognized by the University for the subject for which you are recognized as Ph.D./M.Phil Research Guide.
- No fresh Ph.D./M.Phil 'Research Students' should be registered with Ph.D./M.Phil Research Guides whose length of service as a regular faculty is left not more than one year and in such case you have to compulsorily assign Co- guide to the Research Students working under you.

Recognition granted to you is always subject to the terms and conditions prescribed by the University and University Grants Commission, New Delhi from time to time, in this behalf.

If any correction in the recognition letter then please contact this office within fifteen days from the date of receipt of this letter.

iv) If you change the existing College/ Institute, after getting University teacher approval, you have to apply online for address change.



(Dr. M.V. Rasve)  
Deputy Registrar

**Copy fws to :**

1. The Dean, Faculty of Science and Technology.
2. The Principal, Sahyadri Shikshan Sanstha Mahant Jamanadas Maharaj College Addr: At post Karanjali Ta: Peth Dist: Nashik.
3. The Deputy Registrar (Admission), Savitribai Phule Pune University, Pune-411 007.



**Principal**  
M.J.M. Arts, Commerce &  
Science College Karajali,  
Tal.Peth, Dist.Nashik

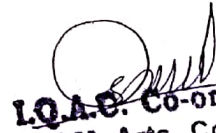

**L.Q.A.C. Co-ordinator**  
M.J.M. Arts, Commerce  
and Science College  
Karanjali, Nashik-422 208

Savitribai Phule Pune University  
(Formerly University of Pune)



Tel. Nos: (020) 2562 1227/1212/1205  
Fax no. : 020 25699232

Ganeshkhind, Pune - 07  
Email : pgadmis@pun.unipune.ac.in

Ref. No.: PGS/PGS/5433

Date :18/11/2022

To,  
The Principal / Director / Head  
Maratha Vidya Prasarak Samaj KRT Arts BH  
Commerce and AM Science College (KTHM)  
Nashik Addr: Shivajinagar Gangapur Road  
Nashik Ta: Nashik Dist: Nashik [CAAN017440  
]

Sir/Madam

The Ph.D. cases forwarded by your Institute/Centre were placed before the Research & Recognition Committee in Botany (Science and Technology) held on 18/11/2022. The decision/s of Research & Recognition Committee are as follows :

Sr.No.	Name of the candidate & Name of the Guide	Remarks
1.	Surbhi Bhausaheb Bhalerao Guide : Dr. Jondhale Avinash Shivaji 	Topic Approved and Admitted w.e.f. 27/07/2022 as follows :- In Vitro Studies and Phytochemical Analysis of Bacopa Monnieri (L) Pennell

Please comply with the directions of Research & Recognition Committee and University Communicate to this office at the earliest.

Thanking You,

Yours faithfully,

Assistant Registrar  
(P.G.Admissions)

Copy to :

1. Mr./Ms. Surbhi Bhausaheb Bhalerao  
Maratha Vidya Prasarak Samaj KRT Arts BH Commerce and AM Science College (KTHM) Nashik Addr:  
Shivajinagar Gangapur Road Nashik Ta: Nashik Dist: Nashik
2. Dr.Jondhale Avinash Shivaji  
Maratha Vidya Prasarak Samaj KRT Arts BH Commerce and AM Science College (KTHM) Nashik Addr:  
Shivajinagar Gangapur Road Nashik Ta: Nashik Dist: Nashik

  
Principal  
M.J.M. Arts, Commerce &  
Science College Karanjali  
Tal.Peth, Dist.Nashik

  
L.Q.A.C. Co-ordinator  
M.J.M. Arts, Commerce  
and Science College  
Karanjali, Nashik-422 701

Savitribai Phule Pune University  
(Formerly University of Pune)



Tel. Nos: (020) 2562 1227/1212/1205  
Fax no. : 020 25699232

Ganeshkhind, Pune - 07  
Email : pgadmis@pun.unipune.ac.in

Ref. No.: PGS/PGS/1965

Date :24/04/2023

To,  
The Principal / Director / Head  
Maratha Vidya Prasarak Samaj KRT Arts BH  
Commerce and AM Science College (KTHM)  
Nashik Addr: Shivajinagar Gangapur Road  
Nashik Ta: Nashik Dist: Nashik [CAAN017440  
]

Sir/Madam

The Ph.D. cases forwarded by your Institute/Centre were placed before the Research & Recognition Committee in Botany (Science and Technology) held on 18/11/2022. The decision/s of Research & Recognition Committee are as follows :

Sr.No.	Name of the candidate & Name of the Guide	Remarks
1.	Bharat Trimbak Magar Guide : Dr. Jondhale Avinash Shivaji 	Topic Approved and Admitted w.e.f. 27/07/2022 as follows :- Effective Potential Role of Aqueous Plant Extract Against Root Knot Nematode in Tomato Crop

Please comply with the directions of Research & Recognition Committee and communicate to this office at the earliest.

Thanking You,

Yours faithfully,

Deputy Registrar  
(P.G.Admissions)

Copy to :

1. Mr./Ms. Bharat Trimbak Magar  
Maratha Vidya Prasarak Samaj KRT Arts BH Commerce and AM Science College (KTHM) Nashik Addr:  
Shivajinagar Gangapur Road Nashik Ta: Nashik Dist: Nashik
2. Dr.Jondhale Avinash Shivaji  
Maratha Vidya Prasarak Samaj KRT Arts BH Commerce and AM Science College (KTHM) Nashik Addr:  
Shivajinagar Gangapur Road Nashik Ta: Nashik Dist: Nashik

  
**Principal**  
M.J.M. Arts, Commerce &  
Science College Karajali,  
Tal.Peth, Dist.Nashik

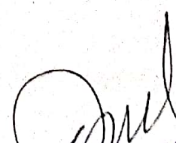
  
**L.Q.A.C. Co-ordinator**  
M.J.M. Arts, Commerce  
and Science College  
Karanjall, Nashik-422 208

Savitribai Phule Pune University  
(Formerly University of Pune)



Tel. Nos: (020) 2562 1227/1212/1205  
Fax no. : 020 25699232

Ganeshkhind, Pune - 07  
Email : pgadmis@pun.unipune.ac.in

Ref. No.: PGS/PGS/3856

Date : 13/09/2023

To,  
The Principal / Director / Head  
Maratha Vidya Prasarak Samaj KRT Arts BH  
Commerce and AM Science College (KTHM)  
Nashik Addr: Shivajinagar Gangapur Road  
Nashik Ta: Nashik Dist: Nashik [CAAN017440  
]

Sir/Madam

The Ph.D. cases forwarded by your Institute/Centre were placed before the Research & Recognition Committee in Botany (Science and Technology) held on 17/08/2023. The decision/s of Research & Recognition Committee are as follows :

Sr.No.	Name of the candidate & Name of the Guide	Remarks
1.	Nisha Balu Suryawanshi Guide : Dr. Chavan Smita Pandurang Co-Guide : Jondhale Avinash Shivaji 	Topic Approved and Admitted w.e.f. 31/07/2023 as follows :- Phytochemical Screening and Green Synthesis of Silver Nanoparticles Using Leaf Extracts of Malvastrum coromandelianum (L.) Garcke and Berberis aristata DC.

Please comply with the directions of Research & Recognition Committee and communicate to this office at the earliest.

Thanking You,

Yours faithfully,

Deputy Registrar  
(P.G.Admissions)

Copy to :

1. Mr./Ms. Nisha Balu Suryawanshi  
Maratha Vidya Prasarak Samaj KRT Arts BH Commerce and AM Science College (KTHM) Nashik Addr:  
Shivajinagar Gangapur Road Nashik Ta: Nashik Dist: Nashik
2. Dr.Chavan Smita Pandurang  
Maratha Vidya Prasarak Samaj KRT Arts BH Commerce and AM Science College (KTHM) Nashik Addr:  
Shivajinagar Gangapur Road Nashik Ta: Nashik Dist: Nashik
3. Jondhale Avinash Shivaji  
At/Post:- Nimagaonjali, Taluka:- Sangamner, District:- Ahmednagar, Maharashtra state, India, PIN-413 714,

Principal  
M.J.M. Arts, Commerce &  
Science College Karajali,  
Tal.Peth, Dist.Nashik

I.Q.A.C. Co-ordinator  
M.J.M. Arts, Commerce  
and Science College  
Karajali, Nashik-422 208



सावित्रीबाई फुले पुणे विद्यापीठ  
गणेशखिंड, पुणे - ४११ ००७.  
Savitribai Phule Pune University  
Ganeshkhind, Pune - 411007.



सावित्रीबाई फुले पुणे विद्यापीठ  
गणेशखिंड, पुणे - ४११ ००७.

दूरध्वनी क्रमांक : ०२० - २५६२१२०५  
Telephone : 020 - 25621205  
ईमेल / Email : pgadmis@pun.unipune.ac.in

शैक्षणिक प्रवेश विभाग  
P. G. Admissions Section  
वेबसाइट / Website: www.unipune.ac.in

Ref. No.: PGS/PGS/574

Date :21/02/2024

To,  
The Principal / Director / Head  
Maratha Vidya Prasarak Samaj KRT Arts BH  
Commerce and AM Science College (KTHM)  
Nashik Addr: Shivajinagar Gangapur Road  
Nashik Ta: Nashik Dist: Nashik [CAAN017440  
]

Sir/Madam

The Ph.D. cases forwarded by your Institute/Centre were placed before the Research & Recognition Committee in Botany (Science and Technology) held on 07/02/2024. The decision/s of Research & Recognition Committee are as follows :

Sr.No.	Name of the candidate & Name of the Guide	Remarks
1.	Sagar Narayan Bhagwat Guide : Dr. Jondhale Avinash Shivaji 	Topic Approved and Admitted w.e.f. 31/07/2023 as follows :- In Vitro Studies on Important Medicinal Plant of Uraria picta (Jacq.) DC.

Please comply with the directions of Research & Recognition Committee and communicate to this office at the earliest.

Thanking You,

Mr. Shripad Burkule  
Assistant Registrar

Copy to :

1. Mr./Ms. Sagar Narayan Bhagwat  
Maratha Vidya Prasarak Samaj KRT Arts BH Commerce and AM Science College (KTHM) Nashik Addr:  
Shivajinagar Gangapur Road Nashik Ta: Nashik Dist: Nashik
2. Dr.Jondhale Avinash Shivaji  
Maratha Vidya Prasarak Samaj KRT Arts BH Commerce and AM Science College (KTHM) Nashik Addr:  
Shivajinagar Gangapur Road Nashik Ta: Nashik Dist: Nashik

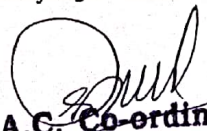
  
I.Q.A.C. Co-ordinator  
M.J.M. Arts, Commerce  
and Science College  
Karanjali, Nashik-422 208

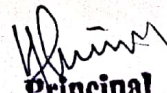
  
Principal  
M.J.M. Arts, Commerce  
and Science College  
Karanjali, Nashik-422 208



Tel. Nos: (020) 2562 1227/1212/1205  
Fax no. : 020 25699232

Ganeshkhind, Pune - 07  
Email : pgsadmis@pun.unipune.ac.in

Ref. No.: PGS/660

Date :06/10/2023

To,  
The Principal / Director / Head  
Mahatma Gandhi Vidyamandirs Loknete  
Vyankatrao Hiray Arts Science and Commerce  
College Addr: Panchavati Nashik-422003 Ta:  
Nashik Dist: Nashik [CAAN018160]

Sir/Madam

The Ph.D. cases forwarded by your Institute/Centre were placed before the Research & Recognition Committee in Chemistry (Science and Technology) held on 09/09/2023. The decision/s of Research & Recognition Committee are as follows :

Sr.No.	Name of the candidate & Name of the Guide	Remarks
1.	Satyam Sham Bakare Guide : Dr. Waghchaure Ravindra Haribhau 	Topic Approved and Admitted w.e.f. 14/07/2023 as follows :- Synthesis, characterization and photocatalytic applications of transition and non-transition element doped ZnO nanomaterial for dye degradation

Please comply with the directions of Research & Recognition Committee and communicate to this office at the earliest.

Thanking You,

Yours faithfully,

Deputy Registrar  
(P.G.Admissions)

Copy to :

1. Mr./Ms. Satyam Sham Bakare  
Mahatma Gandhi Vidyamandirs Loknete Vyankatrao Hiray Arts Science and Commerce College Addr: Panchavati  
Nashik-422003 Ta: Nashik Dist: Nashik
2. Dr. Waghchaure Ravindra Haribhau  
Mahatma Gandhi Vidyamandirs Loknete Vyankatrao Hiray Arts Science and Commerce College Addr: Panchavati  
Nashik-422003 Ta: Nashik Dist: Nashik

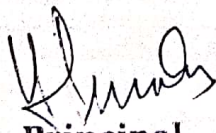
  
**Principal**  
M.J.M. Arts, Commerce &  
Science College Karajali,  
Tal.Peth, Dist.Nashik

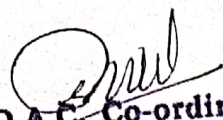
  
**I.Q.A.C. Co-ordinator**  
M.J.M. Arts, Commerce  
and Science College  
Karanjali, Nashik-422 208

Savitribai Phule Pune University  
(Formerly University of Pune)



Tel. Nos: (020) 2562 1227/1212/1205  
Fax no. : 020 25699232

Ganeshkhind, Pune - 07  
Email : pgadmis@pun.unipune.ac.in

Ref. No.: PGS/1187

Date :23/06/2022

To,  
The Principal / Director  
Shri Neminath Jain Brahmacharyashram Shri  
Neminath Jain Brahmacharyashram(Jain  
Gurukul) Karmaveer Keshavlalji Harakchandji  
Abad Arts And Shriman M.G.Lodha  
Commerce & Shriman P.H. Jain Science  
College Chandwad Addr: Neminagar  
Chandwad Ta: Chandwad Dist: Nashik  
[CAAN017450]

Sir/Madam

The Ph.D. cases forwarded by your Institute/Centre were placed before the Research & Recognition Committee in Physics (Science and Technology) held on 20/06/2022. The decision/s of Research & Recognition Committee are as follows :

Sr.No.	Name of the candidate & Name of the Guide	Remarks
1.	Abhinay Subhash Mandawade Guide : Dr. Shinde Mahendra Shantaram 	Topic Approved and Admitted w.e.f. 19/04/2022as follows :- Synthesis of Vanadium Oxide, Bismuth Oxide and Indium Oxide Nanostructure and their Applications in Gas Sensing and Photocatalytic Activity

Please comply with the directions of Research & Recognition Committee and University Communicate to this office at the earliest.

Thanking You,

Yours faithfully,

Assistant Registrar  
(P.G.Admissions)

Copy to :

1. Mr./Ms. Abhinay Subhash Mandawade  
Shri Neminath Jain Brahmacharyashram Shri Neminath Jain Brahmacharyashram(Jain Gurukul) Karmaveer  
Keshavlalji Harakchandji Abad Arts And Shriman M.G.Lodha Commerce & Shriman P.H. Jain Science College  
Chandwad Addr: Neminagar Chandwad Ta: Chandwad Dist: Nashik
2. Dr.Shinde Mahendra Shantaram  
Shri Neminath Jain Brahmacharyashram Shri Neminath Jain Brahmacharyashram(Jain Gurukul) Karmaveer  
Keshavlalji Harakchandji Abad Arts And Shriman M.G.Lodha Commerce & Shriman P.H. Jain Science College  
Chandwad Addr: Neminagar Chandwad Ta: Chandwad Dist: Nashik

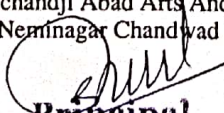
  
Principal  
M.J.M. Arts, Commerce &  
Science College Karajali,  
Tal.Peth, Dist.Nashik

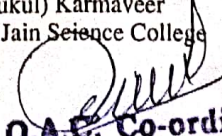
  
I.Q.A.C. Co-ordinator  
M.J.M. Arts, Commerce  
and Science College  
Karanjali, Nashik-422 208



Savitribai Phule Pune University  
(Formerly University of Pune)



Tel. Nos: (020) 2562 1227/1212/1205  
Fax no. : 020 25699232

Ganeshkhind, Pune - 07  
Email : pgadmis@pun.unipune.ac.in

Ref. No.: PGS/PGS/1187

Date :23/06/2022

To,  
The Principal / Director  
Shri Neminath Jain Brahmacharyashram Shri  
Neminath Jain Brahmacharyashram(Jain  
Gurukul) Karmaveer Keshavlalji Harakchandji  
Abad Arts And Shriman M.G.Lodha  
Commerce & Shriman P.H. Jain Science  
College Chandwad Addr: Neminagar  
Chandwad Ta: Chandwad Dist: Nashik  
[CAAN017450]

Sir/Madam

The Ph.D. cases forwarded by your Institute/Centre were placed before the Research & Recognition Committee in Physics (Science and Technology) held on 20/06/2022. The decision/s of Research & Recognition Committee are as follows :

Sr.No.	Name of the candidate & Name of the Guide	Remarks
1.	Laxman Namdeo Bhoje Guide : Dr. Shinde Mahendra Shantaram Co-Guide : Dr G.E. Patil 	Topic Approved and Admitted w.e.f. 19/04/2022as follows :- Studies on Gas Sensing Properties of Nanocrystalline Zirconium Dioxide and Nickel Oxide Thin Films

Please comply with the directions of Research & Recognition Committee and University Communicate to this office at the earliest.

Thanking You,

Yours faithfully,

Assistant Registrar  
(P.G.Admissions)

Copy to :

1. Mr./Ms. Laxman Namdeo Bhoje  
Shri Neminath Jain Brahmacharyashram Shri Neminath Jain Brahmacharyashram(Jain Gurukul) Karmaveer Keshavlalji Harakchandji Abad Arts And Shriman M.G.Lodha Commerce & Shriman P.H. Jain Science College Chandwad Addr: Neminagar Chandwad Ta: Chandwad Dist: Nashik
2. Dr.Shinde Mahendra Shantaram  
Shri Neminath Jain Brahmacharyashram Shri Neminath Jain Brahmacharyashram(Jain Gurukul) Karmaveer Keshavlalji Harakchandji Abad Arts And Shriman M.G.Lodha Commerce & Shriman P.H. Jain Science College Chandwad Addr: Neminagar Chandwad Ta: Chandwad Dist: Nashik
3. Dr G.E. Patil  
Shri. Neminath jain College, Chandwad, Nashik

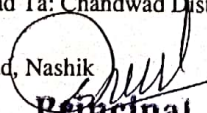
  
Principal  
M.J.M. Arts, Commerce &  
Science College Karajali,  
Tal.Peth, Dist.Nashik

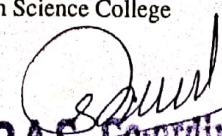
  
I.Q.A.C. Co-ordinator  
M.J.M. Arts, Commerce  
and Science College  
Karanjali, Nashik-422 208

Savitribai Phule Pune University  
(Formerly University of Pune)



Tel. Nos: (020) 2562 1227/1212/1205  
Fax no. : 020 25699232

Ganeshkhind, Pune - 07  
Email : pgadmis@pun.unipune.ac.in

Ref. No.: PGS/PGS/1187

Date :23/06/2022

To,  
The Principal / Director / Head  
Shri Neminath Jain Brahmacharyashram Shri  
Neminath Jain Brahmacharyashram(Jain  
Gurukul) Karmaveer Keshavlalji Harakchandji  
Abad Arts And Shriman M.G.Lodha  
Commerce & Shriman P.H. Jain Science  
College Chandwad Addr: Neminagar  
Chandwad Ta: Chandwad Dist: Nashik  
[CAAN017450]

Sir/Madam

The Ph.D. cases forwarded by your Institute/Centre were placed before the Research & Recognition Committee in Physics (Science and Technology) held on 20/06/2022. The decision/s of Research & Recognition Committee are as follows :

Sr.No.	Name of the candidate & Name of the Guide	Remarks
1.	Laxmi Dilip Sonawane Guide : Dr. Shinde Mahendra Shantaram Co-Guide : Dr G.E. Patil 	Topic Approved and Admitted w.e.f. 19/04/2022 as follows :- Synthesis of Cerium Oxide, Silicon Oxide Nanostructures and their Applications in Gas Sensing and Photocatalytic Activity

Please comply with the directions of Research & Recognition Committee and University Communicate to this office at the earliest.

Thanking You,

Yours faithfully,

Assistant Registrar  
(P.G.Admissions)

Copy to :

1. Mr./Ms. Laxmi Dilip Sonawane  
Shri Neminath Jain Brahmacharyashram Shri Neminath Jain Brahmacharyashram(Jain Gurukul) Karmaveer Keshavlalji Harakchandji Abad Arts And Shriman M.G.Lodha Commerce & Shriman P.H. Jain Science College Chandwad Addr: Neminagar Chandwad Ta: Chandwad Dist: Nashik
2. Dr.Shinde Mahendra Shantaram  
Shri Neminath Jain Brahmacharyashram Shri Neminath Jain Brahmacharyashram(Jain Gurukul) Karmaveer Keshavlalji Harakchandji Abad Arts And Shriman M.G.Lodha Commerce & Shriman P.H. Jain Science College Chandwad Addr: Neminagar Chandwad Ta: Chandwad Dist: Nashik
3. Dr G.E. Patil  
Shri. Neminath Jain College, Chandwad, Nashik

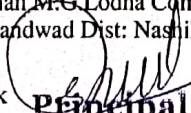
  
Principal  
M.J.M. Arts, Commerce &  
Science College Karajali.  
Tal.Peth, Dist.Nashik

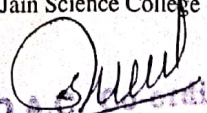
  
L.O. Coordinator  
M.J.M. Arts, Commerce  
and Science College  
Karajali, Nashik-422 208

Savitribai Phule Pune University  
(Formerly University of Pune)



Tel. Nos: (020) 2562 1227/1212/1205  
Fax no. : 020 25699232

Ganeshkhind, Pune - 07  
Email : pgadmis@pun.unipune.ac.in

Ref. No.: PGS/PGS/1256

Date :11/07/2022

To,  
The Principal / Director / Head  
Shri Neminath Jain Brahmacharyashram Shri  
Neminath Jain Brahmacharyashram(Jain  
Gurukul) Karmaveer Keshavlalji Harakchandji  
Abad Arts And Shriman M.G.Lodha  
Commerce & Shriman P.H. Jain Science  
College Chandwad Addr: Neminagar  
Chandwad Ta: Chandwad Dist: Nashik  
[CAAN017450]

Sir/Madam

The Ph.D. cases forwarded by your Institute/Centre were placed before the Research & Recognition Committee in Physics (Science and Technology) held on 20/06/2022. The decision/s of Research & Recognition Committee are as follows :

Sr.No.	Name of the candidate & Name of the Guide	Remarks
1.	Swapnil Santosh Tayade Guide : Dr. Shinde Mahendra Shantaram 	Topic Approved and Admitted w.e.f. 19/04/2022as follows :- SnO2 based Nanostructured Semiconductor Sensitized Solar Cell

Please comply with the directions of Research & Recognition Committee and University Communicate to this office at the earliest.

Thanking You,

Yours faithfully,

Assistant Registrar  
(P.G.Admissions)

Copy to :

1. Mr./Ms. Swapnil Santosh Tayade  
Shri Neminath Jain Brahmacharyashram Shri Neminath Jain Brahmacharyashram(Jain Gurukul) Karmaveer Keshavlalji Harakchandji Abad Arts And Shriman M.G.Lodha Commerce & Shriman P.H. Jain Science College Chandwad Addr: Neminagar Chandwad Ta: Chandwad Dist: Nashik
2. Dr.Shinde Mahendra Shantaram  
Shri Neminath Jain Brahmacharyashram Shri Neminath Jain Brahmacharyashram(Jain Gurukul) Karmaveer Keshavlalji Harakchandji Abad Arts And Shriman M.G.Lodha Commerce & Shriman P.H. Jain Science College Chandwad Addr: Neminagar Chandwad Ta: Chandwad Dist: Nashik

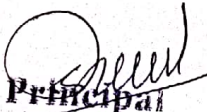
  
Principal  
M.J.M. Arts, Commerce &  
Science College Karajali,  
Tal.Peth, Dist.Nashik

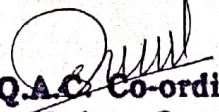
  
I.Q.A.C. Co-ordinator  
M.J.M. Arts, Commerce  
and Science College  
Karanjali, Nashik-422 208